

PEOPLE'S DEMOCRATIC REPUBLIC OF ALGERIA  
MINISTRY OF HIGHER EDUCATION AND RESEARCH  
UNIVERSITY OF SAAD DAHLEB-BLIDA  
Institute of Aeronautics and Space Studies

Avionics Major



Memory Submitted  
In Partial Fulfillment of The Requirements  
For **MASTERS DEGREE** of Science

*Presented by:*

**Belhamel Tahar  
Azrou Idir**

---

**Guidance and control of surface to air missile with  
nonlinear varying parameters**

---

*In front of the jury composed of :*

<b>BENTRAD Hocine</b>	MCB	IAESB	President
<b>BEKHITI Belkacem</b>	MCB	IAESB	Supervisor
<b>DILMI Smain</b>	MCB	IAESB	Co-supervisor
<b>CHEGRANI Ahmed</b>	MCB	IAESB	Examiner

*Academic Year 2019 - 2020*



# Dedication

*I dedicate this humble project to my parents, to my brother  
and sisters and to anyone who helped me  
in my academic career from near or far.*

*Azrou Idir*

# Dedication

*I dedicate this humble work to my adorable parents whom help me and stand with me in every moment in my life.*

*To my brothers and sisters for their support and their advices.*

*To my best partner thesis "Azrou Idir"*

*To all relatives, friends and others who in one way or another shared their support, either morally, financially and physically.*

*Thank you.*

*Belhamel Tahar*

# Acknowledgements

*In the name of Allah, the most Gracious, the most Merciful.*

*All praise and thanks are due to Allah alone. Blessings and peace be upon prophet Muhammad, his family, companions and all those who follow in his footsteps till the end of time.*

*We would like to thank our thesis supervisor  
Dr.Bekhiti Belkacem for his  
help during the work's period.*

*We also thank so much all people  
that contributed to our present work.*

# Abstract

Over the last three decades, there have been many studies in the area of missile guidance and control. The result has been a great deal of progress and several approaches to the problem have emerged. The basic problem is to intercept a target with great accuracy in an environment that is uncertain and noisy. One of the earliest forms of missile guidance is that of command to line of sight and proportional navigation, this involves establishing a line of sight between the tracking sensor and the target. This work investigates the guidance and control design problem for a generic surface to air missile intercepting a given target using different optimised guidance laws which are the optimised commznd to LOS, PN, and PD based guidance. The performances of these guidance laws are tested against a given target in terms of the acheived miss-distance and the time of closest approach. Furethermore, qualitative comparative study between the aforementioned guidance laws is presented.

## ملخص

على مدى العقود الثلاثة الماضية كانت هناك العديد من الدراسات في مجال توجيه الصواريخ والتحكم بها، وكانت النتيجة ظهور العديد من الطرائق لحل إشكالية التحكم في الصواريخ الموجهة ما أدى إلى تقدم كبير في هذا المجال. والمشكلة الأساسية هي اعتراض الهدف بدقة كبيرة في بيئة غير مؤكدة ومليئة بالضوضاء. أحد أقدم أشكال التوجيه هو القيادة نحو خط الرؤية أو التوجيه عن طريق قانون الملاحظة النسبي، وهذا يعتمد على إنشاء خط رؤية بين المستشعر والهدف. هذا العمل الذي قدمناه يعالج مشكلة تصميم التوجيه والتحكم في صاروخ أرض جو يعترض هدفاً معيناً باستخدام قوانين توجيه مختلفة. يتم اختبار أداء قوانين التوجيه هذه مقابل هدف يطير على ارتفاع معين من حيث المسافة الفاصلة المحققة ووقت الاقتراب الأقصر. في الأخير تم تقديم دراسة ومقارنة نوعية بين قوانين التوجيه المستعملة.



# Contents

<b>Dedication</b>	<b>3</b>
<b>Dedication</b>	<b>4</b>
<b>Acknowledgements</b>	<b>5</b>
<b>Abstract</b>	<b>6</b>
<b>Notations and acronyms</b>	<b>15</b>
<b>General Introduction</b>	<b>21</b>
<b>1 Mathematical background</b>	<b>23</b>
1.1 Introduction	23
1.2 Basic definitions and vector operations	23
1.2.1 Scalar Product	23
1.2.2 Vector product	24
1.2.2.1 Alternative ways to compute the cross product	25
1.2.3 Vector triple product	26
1.2.4 Mixed Triple Product of Three Vectors	26
1.2.5 Magnitude and direction of a vector	27
1.2.5.1 The unit vector	27
1.2.5.2 The direction angle	27
1.2.5.3 The direction cosines	28
1.2.6 Change of basis (Change of frames)	28
1.2.7 Derivative of vectors	29
1.2.8 Differentiation: chain rule	30
1.2.9 Linear momentum	30
1.2.10 Angular momentum	30
<b>2 Missile system description</b>	<b>32</b>
2.1 Introduction	32
2.2 Classification of missiles	32
2.3 Missile components	33
2.3.1 Seeker	33
2.3.1.1 Optical seekers	34
2.3.1.2 Radio Frequency Seekers	35
2.3.2 Autopilot	36
2.3.3 Control system	36
2.3.4 Guidance system	36
2.3.5 Warhead	36



2.3.5.1	Shaped Charge . . . . .	36
2.3.5.2	Continuous Rod . . . . .	37
2.3.5.3	Fragment . . . . .	38
2.3.6	Fuze . . . . .	38
2.3.6.1	Impact fuze . . . . .	38
2.3.6.2	Proximity Fuze . . . . .	39
2.3.7	Airframe . . . . .	40
2.3.8	Propulsion system . . . . .	40
2.3.8.1	Atmospheric jet propulsion system . . . . .	41
2.3.8.2	Thermal jet propulsion system . . . . .	42
<b>3</b>	<b>Mathematical modeling of a missile</b>	<b>45</b>
3.1	Introduction . . . . .	45
3.2	Forces and moments . . . . .	45
3.2.1	Aerodynamic forces and moments . . . . .	46
3.2.1.1	Aerodynamic forces . . . . .	46
3.2.1.2	Aerodynamic moments . . . . .	47
3.2.2	Propulsion forces and moments . . . . .	47
3.2.2.1	Thrust force . . . . .	47
3.2.2.2	Thrust moment . . . . .	50
3.2.3	Gravitational force . . . . .	50
3.2.3.1	Newtonian Gravitation . . . . .	50
3.2.3.2	Gravity in Rotating Earth Frame . . . . .	51
3.3	Motion of rigid body on fixed point . . . . .	52
3.4	The general motion of a rigid body in space . . . . .	53
3.5	Equations of motion . . . . .	54
3.5.1	Translational equations . . . . .	55
3.5.2	Rotational equations . . . . .	57
3.5.3	Rate of change of Euler angles . . . . .	61
<b>4</b>	<b>Aerodynamics of a missile</b>	<b>67</b>
4.1	Introduction . . . . .	67
4.2	Aerodynamic properties . . . . .	67
4.2.1	Force coefficients . . . . .	69
4.2.2	Components of force coefficients . . . . .	70
4.2.2.1	Drag coefficient $C_D$ . . . . .	70
4.2.2.2	Lift coefficient $C_L$ . . . . .	70
4.2.3	Components of moment coefficients . . . . .	70
4.3	Atmospheric properties . . . . .	73
<b>5</b>	<b>Guidance and control system</b>	<b>75</b>
5.1	Introduction . . . . .	75
5.2	Guidance intercept techniques . . . . .	76
5.2.1	Homing guidance or onboard guidance . . . . .	76
5.2.1.1	Active homing . . . . .	76
5.2.1.2	Semiactive homing . . . . .	76
5.2.1.3	Passive homing . . . . .	77
5.2.2	Ground based guidance . . . . .	77
5.2.2.1	Command guidance . . . . .	78
5.2.2.2	Beam Rider . . . . .	79
5.2.2.3	Retransmission Guidance or TVM guidance . . . . .	79

5.3	Missile autopilot . . . . .	80
5.3.1	Autopilot Modeling . . . . .	81
5.3.1.1	Six degree of freedom model . . . . .	81
5.3.1.2	Five degree of freedom model . . . . .	82
5.4	Missile control system . . . . .	82
5.4.1	Fin deflection control . . . . .	82
5.4.1.1	Canard control . . . . .	82
5.4.1.2	Tail control . . . . .	83
5.4.2	Thrust vector control . . . . .	83
5.4.3	Control system modeling . . . . .	84
5.5	Guidance laws . . . . .	86
5.5.1	Beam rider or line of sight guidance . . . . .	86
5.5.2	Proportional navigation . . . . .	88
5.5.3	Proportional derivative based guidance law . . . . .	91
5.5.4	Optimisation techniques applied to guidance laws . . . . .	93
5.5.4.1	Introduction . . . . .	93
5.5.4.2	PSO algorithm . . . . .	93
<b>6</b>	<b>Application of guidance laws to a generic surface to air missile</b>	<b>95</b>
6.1	Introduction . . . . .	95
6.2	Program structure . . . . .	95
6.3	Simulation of a missile launch . . . . .	98
6.4	Simulation results of missile-target 3D-engagement . . . . .	107
6.4.1	Target in straight flight with constant speed . . . . .	107
6.4.1.1	Proportional Navigation results . . . . .	108
6.4.1.2	Beam Rider or Command to line of sight results . . . . .	113
6.4.1.3	PD based guidance results . . . . .	118
6.4.2	Target in a weaving flight . . . . .	122
6.4.2.1	Proportional Navigation results . . . . .	123
6.4.2.2	Beam Rider or Command to line of sight results . . . . .	128
6.4.2.3	PD based guidance results . . . . .	133
6.5	Comparison between simulation results . . . . .	138
6.5.1	Target in straight flight . . . . .	138
6.5.2	Target in weaving flight . . . . .	138
	<b>General conclusion</b>	<b>140</b>
<b>A</b>	<b>Appendix</b>	<b>141</b>
A.1	MATLAB programs . . . . .	141
A.1.1	Missile flight simulation CODE . . . . .	141
A.1.2	ODE's function CODE . . . . .	153
A.1.3	THRUST interpolation CODE . . . . .	154
A.1.4	PSO Algorithm CODE . . . . .	155
<b>B</b>	<b>Appendix</b>	<b>157</b>
B.1	Numerical solution of a differential equation . . . . .	157
B.1.1	Runge-Kutta Method . . . . .	157
B.2	Coordinate system . . . . .	158
B.2.1	Earth Coordinate System ( $x_e, y_e, z_e$ ) . . . . .	158
B.2.2	Body Coordinate System ( $x_b, y_b, z_b$ ) . . . . .	158
B.2.3	Wind Coordinate System ( $x_w, y_w, z_w$ ) . . . . .	158

**Bibliography**

**158**

# List of Figures

1.1	The dot product of two vectors A and B. . . . .	24
1.2	Vector product of two vectors A and B. . . . .	24
1.3	The memory circle and reference frame . . . . .	25
1.4	Mixed product of three vectors $\vec{A}$ , $\vec{B}$ and $\vec{C}$ . . . . .	26
1.5	Unit vector $\vec{u}$ of corresponding vector $\vec{r}$ . . . . .	27
1.6	Direction angles $\alpha$ , $\beta$ and $\gamma$ of vector $\vec{r}$ . . . . .	28
1.7	The derivative of vector. . . . .	29
1.8	Diagram represents the derivative of $w$ with respect to $t$ . . . . .	30
1.9	The angular momentum . . . . .	31
2.1	Missile components . . . . .	33
2.2	Seeker head configuration . . . . .	33
2.3	Seeker gimbal . . . . .	34
2.4	Generic IR seeker and its location in missile . . . . .	34
2.5	Radio frequency seeker . . . . .	35
2.6	Passive seeker . . . . .	35
2.7	Semi-active seeker . . . . .	35
2.8	Active seeker . . . . .	36
2.9	Shaped charge warhead and its implimentation in 3D . . . . .	37
2.10	Continuous rod warhead explosion test . . . . .	37
2.11	Fragments warhead and its explosion test . . . . .	38
2.12	Impact fuze before and after impact . . . . .	39
2.13	Impact fuze . . . . .	39
2.14	Proximity fuze . . . . .	40
2.15	Pulsejet engine . . . . .	41
2.16	Ramjet engine . . . . .	41
2.17	Turbojet engine . . . . .	42
2.18	A simplified liquid propellant rocket . . . . .	42
2.19	A simplified solid propellant rocket . . . . .	43
2.20	Combined propellant . . . . .	44
3.1	Forces, Velocities, Moments, and Angular Rates in Body Reference Frame . . . . .	45
3.2	Aerodynamic Force in Body and Wind-Frame Coordinates . . . . .	46
3.3	Mass variation . . . . .	49
3.4	General rigid body with angular velocity vector $\omega$ about its center of mass. . . . .	53
3.5	The relative position vector . . . . .	57
3.6	First rotation (Heading, Yaw angle $\psi$ ) . . . . .	62
3.7	Second rotation (pitch angle $\theta$ ) . . . . .	62
3.8	Third rotation (Roll angle $\phi$ ) . . . . .	63
4.1	Aerodynamic characteristics of missile . . . . .	68

4.2 Atmosphere characteristics. . . . .	74
5.1 Guidance loop . . . . .	75
5.2 Active homing . . . . .	76
5.3 Semiactive homing . . . . .	77
5.4 Passive homing . . . . .	78
5.5 Command guidance . . . . .	78
5.6 Beam rider guidance . . . . .	79
5.7 TVM guidance . . . . .	80
5.8 Autopilot function . . . . .	81
5.9 Control surfaces . . . . .	81
5.10 Aerodynamic moment in canard control . . . . .	83
5.11 Aerodynamic moment in tail control . . . . .	83
5.12 Aerodynamic moment in canard control . . . . .	84
5.13 Closed loop diagram . . . . .	84
5.14 Guidance Error for Beam Rider or Command to Line of Sight . . . . .	87
5.15 Geometry for derivation of proportional navigation. . . . .	89
5.16 PID controller block diagram. . . . .	91
5.17 Sign function $y = \text{sgn}(x)$ . . . . .	92
5.18 PSO diagram . . . . .	94
6.1 Diagram for computaional cycle of missile flight simulation . . . . .	96
6.2 Input for open loop simulation . . . . .	98
6.3 Thrust variation. . . . .	98
6.4 Mass variation . . . . .	99
6.5 Inertia variation on $x$ , $y$ and $z$ axes respectively . . . . .	100
6.6 Center of mass variation . . . . .	100
6.7 Evolution of atmospheric parameters. . . . .	101
6.8 Mach number variation . . . . .	102
6.9 Gravity variation . . . . .	102
6.10 Evolution of Lift and Drag forces. . . . .	103
6.11 Angle of attack variation . . . . .	103
6.12 Side-slipe angle variation. . . . .	104
6.13 Total angle of attack variation. . . . .	104
6.14 Picth and Yaw momens variation. . . . .	105
6.15 Evolution of Linear velocities. . . . .	105
6.16 Angular velocities variation. . . . .	106
6.17 Euler angles variation. . . . .	106
6.18 Missile trajectory. . . . .	107
6.19 First and second inputs variation . . . . .	108
6.20 Lift and Drag forces variations. . . . .	108
6.21 Angle of attack and Side-slipe angle histories. . . . .	109
6.22 Total angle of attack variation. . . . .	109
6.23 Picth and Yaw momens variation. . . . .	110
6.24 Evolution of Linear velocities. . . . .	110
6.25 Angular velocities variation. . . . .	111
6.26 Euler angles variation. . . . .	111
6.27 Missile and Target engagement in 3 dimensions. . . . .	112
6.28 First and second inputs variation. . . . .	113
6.29 Lift and Drag forces variations. . . . .	113
6.30 Angle of attack and Side-slipe angle variation. . . . .	114

6.31 Total angle of attack variation. . . . .	114
6.32 Pitch and Yaw moments variation. . . . .	115
6.33 Evolution of Linear velocities . . . . .	115
6.34 Angular velocities variation. . . . .	116
6.35 Euler angles variation. . . . .	116
6.36 Missile and Target engagement in 3 dimensions. . . . .	117
6.37 First and second inputs variation. . . . .	118
6.38 Lift and Drag forces variations. . . . .	118
6.39 Angle of attack and Side-slip angle variation. . . . .	119
6.40 Total angle of attack variation . . . . .	119
6.41 Pitch and Yaw moments variation . . . . .	120
6.42 Evolution of Linear velocities . . . . .	120
6.43 Angular velocities variation. . . . .	121
6.44 Euler angles variation. . . . .	121
6.45 Missile and Target engagement in 3 dimensions. . . . .	122
6.46 First and second inputs variation. . . . .	123
6.47 Lift and Drag forces variations. . . . .	124
6.48 Angle of attack and Side-slip angle variation. . . . .	124
6.49 Total angle of attack variation. . . . .	125
6.50 Pitch and Yaw moments variation. . . . .	125
6.51 Evolution of Linear velocities . . . . .	126
6.52 Angular velocities variation. . . . .	126
6.53 Euler angles variation. . . . .	127
6.54 Missile and Target interception. . . . .	127
6.55 First and second inputs variation. . . . .	128
6.56 Lift and Drag forces variations. . . . .	129
6.57 Angle of attack and Side-slip angle variation. . . . .	129
6.58 Total angle of attack variation. . . . .	130
6.59 Pitch and Yaw moments variation. . . . .	130
6.60 Evolution of Linear velocities. . . . .	131
6.61 Angular velocities variation. . . . .	131
6.62 Euler angles variation. . . . .	132
6.63 Missile and Target engagement in 3 dimensions. . . . .	132
6.64 First and second inputs variation. . . . .	133
6.65 Lift and Drag forces variations. . . . .	134
6.66 Angle of attack and Side-slip angle variation. . . . .	134
6.67 Total angle of attack variation. . . . .	135
6.68 Pitch and Yaw moments variation. . . . .	135
6.69 Evolution of Linear velocities . . . . .	136
6.70 Angular velocities variation. . . . .	136
6.71 Euler angles variation. . . . .	137
6.72 Missile and Target engagement in 3 dimensions. . . . .	137

# Notations and acronyms

$A$	Magnitude of aerodynamic axial force vector .
$D$	Magnitude of aerodynamic drag force vector .
$L$	Magnitude of aerodynamic lift force vector .
$N$	Magnitude of aerodynamic normal force vector .
$\alpha$	Angle of attack in pitch plane.
$\beta$	Angle of sideslip.
$\alpha_t$	Total angle of attack .
$A_e$	Rocket nozzle exit area.
$F_p$	Total instantaneous thrust force vector.
$\Delta m_e$	Mass of exhaust gases expelled from missile during time interval.
$\dot{m}_e$	Mass rate of flow of exhaust gas.
$p_a$	Ambient atmospheric pressure.
$p_e$	Average pressure across rocket nozzle exit area.
$v_e$	Absolute velocity of exhaust gases.
$u_{v_e}$	Unit vector in direction of relative exhaust velocity $V_{r_e}$ .
$V_{r_e}$	Velocity vector of expelled exhaust gas relative to center of mass of missile.
$F_{ext}$	vector sum of forces acting on the missile.
$M$	Total moment vector acting on a particle or body.
$m$	Instantaneous mass of missile.
$\dot{m}$	Rate of change of missile mass.

## Notations and acronyms

---

$V$	Absolute linear velocity vector of missile.
$\dot{V}$	Absolute acceleration vector of center of mass of missile.
$P$	Linear momentum vector of the total system.
$P_i$	Initial total system momentum at beginning of time interval.
$P_f$	Final total system momentum at end of time interval.
$v$	Absolute velocity of missile at beginning of time interval.
$\Delta v$	Change in missile velocity during time interval.
$\dot{v}$	Absolute acceleration vector of center of mass of a body.
$F_A$	Resultant aerodynamic force vector.
$F_g$	Gravitational force vector including effects of earth rotation.
$F_G$	Magnitude of the mutual force of gravitational mass attraction between two masses.
$G$	Universal gravitational constant, $6.673 \times 10^{-11} m^3 / (kg - s^2)$ .
$m_1, m_2$	Masses of bodies.
$A_g$	Acceleration vector due to gravitational mass attraction between earth and a free-falling object.
$m_{earth}$	Mass of earth, $5.977 * 10^{24} kg$ .
$R_{cm}$	Distance from earth center to body mass center.
$u_{R_{cm}}$	Unit vector directed from center of earth toward body.
$g_0$	Vector of acceleration due to gravity at earth surface.
$R_e$	Radius vector from earth center to point on earth surface.
$w_e$	Absolute (sidereal) angular rate of the earth.
$g$	Magnitude of acceleration-due-to-gravity vector $g$ .
$h$	Altitude above sea level.
$F_{Ax}, F_{Ay}, F_{Az}$	Components of aerodynamic force vector $F_A$ expressed in the body coordinate system.
$F_{Px}, F_{Py}, F_{Pz}$	Components of propulsive force vector $F_p$ expressed in the body coordinate system.
$F_{gx}, F_{gy}, F_{gz}$	Components of gravitational force vector $F_g$ expressed in the body coordinate system.



## Notations and acronyms

---

$M_x, M_y, M_z$	Components of total momentum.
$L_A, M_A, N_A$	Components of aerodynamic moment vector expressed in body coordinate system (roll, pitch, and yaw, respectively).
$L_P, M_P, N_P$	Components of propulsion moment vector expressed in body coordinate system (roll, pitch, and yaw, respectively).
$\omega$	Angular velocity of the rigid body .
$\dot{\omega}$	Angular acceleration of the rigid body .
$p, q, r$	Components of angular rate vector $\omega$ expressed in the body coordinate system, (roll, pitch and yaw, respectively).
$\dot{p}, \dot{q}, \dot{r}$	Components of angular acceleration $\dot{\omega}$ expressed in body coordinate system (roll, pitch, and yaw, respectively).
$V$	Linear velocity of rigid body.
$u, v, w$	Components of absolute linear velocity vector $V$ expressed in the body coordinate system.
$\dot{u}, \dot{v}, \dot{w}$	Components of linear acceleration expressed in the body coordinate system.
$H_x, H_y, H_z$	Components of the angular momentum.
$[I]$	Inertia matrix of a body.
$I_{xx}, I_{yy}, I_{zz}$	Components of diagonal inertia matrix $[I]$ , (moment of inertia).
$I_{xy}, I_{xz}, I_{yz}$	Products of inertia.
$\vec{r}$	Position of the mass element measured from the center of mass.
$\phi, \theta, \psi$	Euler angles rotations in roll, pitch and yaw respectively.
$\dot{\phi}, \dot{\theta}, \dot{\psi}$	Rate of change of euler angles rotations in roll, pitch and yaw respectively.
$T_1(\phi)$	Rotation matrix about the $x_b$ -axis through the roll angle $\phi$ .
$T_2(\theta)$	Rotation matrix about the $y_b$ -axis through the heading angle $\theta$ .
$T_3(\psi)$	Rotation matrix about the $z_b$ -axis through the heading angle $\psi$ .
$\mathbf{T}(\phi, \theta, \psi)$	General rotation matrix about the three axes pitch, yaw and roll.
$x, y, z$	Coordinate axes in right-handed coordinate system.
$x_b, y_b, z_b$	Coordinates of the body coordinate system.
$i_b, j_b, k_b$	Unit vectors in directions of $x_b, y_b$ and $z_b$ axes, respectively.

## Notations and acronyms

---

$x_{b0}, y_{b0}, z_{b0}$	Orientation of the body coordinate frame before Euler rotations (aligned with the earth reference frame).
$x_{b1}, y_{b1}, z_{b1}$	Intermediate orientation of the body coordinate frame after the first Euler rotation.
$x_{b2}, y_{b2}, z_{b2}$	Intermediate orientation of the body coordinate frame after the second Euler rotation.
$x_e, y_e, z_e$	Coordinates of earth coordinate system.
$x_w, y_w, z_w$	Coordinates of the wind coordinate system.
$C_F$	general aerodynamic force coefficient.
$F$	general force (aerodynamic).
$S$	aerodynamic reference area.
$\rho$	atmospheric density.
$Mn$	Mach number.
$P_a$	ambient atmospheric pressure.
$Q$	dynamic pressure parameter.
$\alpha$	angle of attack.
$\beta$	side-slip angle.
$V_s$	speed of sound at altitude $h$ .
$R$	gas constant (287.05).
$T$	temperature at altitude .
$\gamma$	ratio of specific heat (1.4).
$Re$	Reynolds Number.
$d$	aerodynamic reference length of body.
$\mu$	atmospheric dynamic viscosity.
$C_D$	aerodynamic drag coefficient.
$C_{D_0}$	zero-lift drag coefficient .
$k$	constant depending on body shape and flow regime.

## Notations and acronyms

---

$C_L$	aerodynamic lift coefficient.
$C_{L_\alpha}$	slope of curve formed by lift coefficient $C_L$ versus angle of attack $\alpha$ .
$C_l$	aerodynamic roll moment coefficient about center of mass.
$C_m$	aerodynamic pitch moment coefficient about center of mass.
$C_n$	aerodynamic yaw moment coefficient about center of mass.
$C_{n_\beta}$	slope of curve formed by yawing moment coefficient $C_n$ versus angle of sideslip.
$C_{n_\delta}$	slope of curve i.e yawing moment coefficient $C_n$ versus control-surface deflection $\delta_y$ .
$C_{m_\alpha}$	slope of curve formed by pitch moment coefficient $C_m$ versus angle of attack $\alpha$ .
$C_{n_\alpha}$	slope of curve i.e. pitch moment coefficient $C_m$ versus control-surface deflection $\delta_p$ .
$\delta_p$	angle of effective control-surface deflection in the pitch direction.
$\delta_r$	effective control-surface deflection angle corresponding to roll.
$\delta_y$	angle of effective control-surface deflection in the yaw direction.
$C_{m_{ref}}$	pitching moment coefficient about reference moment station.
$C_{n_{ref}}$	yawing moment coefficient about reference moment station .
$C_{N_y}$	coefficient corresponding to component of normal force on $y_b$ axis.
$C_{N_z}$	coefficient corresponding to component of normal force on $z_b$ axis.
$C_{n_r}$	yaw damping derivative relative to yaw rate .
$C_{n_{\dot{\beta}}}$	yaw damping derivative relative to angle-of sideslip rate.
$P$	pressure at altitude $h$ .
$P_1$	pressure at given altitude $h_1$ .
$g_0$	magnitude of the acceleration vector $\vec{g}_0$ due to gravity at the earth surface.
$\delta_p$	autopilot pitch fin command,
$\delta_Y$	autopilot yaw fin command,
$\delta_R$	autopilot roll fin commands.
$\delta_i$	deflection angle of $i^{th}$ control surface, $i = 1,2,3,4$ .
$s$	Is the Laplace variable
$\delta(s)$	Laplace transform of the achieved control-surface deflection, rad(deg)
$\delta_c(s)$	Laplace transform of the commanded control-surface deflection, rad(deg)

## Notations and acronyms

---

$G(s)$	Control system transfer function, dimensionless.
$K_s$	servo system gain, $s^{-1}$
$\delta$	angular rate control-surface deflection, rad/s.
$e$	vector of error in missile position relative to the guideline, m
$P_B$	position vector of a point on the guideline at the point of intercept with the error vector $e$ , m
$P_M$	position vector of the missile, m.
$u_{gl}$	unit vector that represents the direction of the guideline.
$\omega_{gl}$	angular rate vector of the guideline, rad/s.
$Mag[]$	the magnitude of the argument vector.
$u_c$	unit vector in the direction of the component of $e$ .
$a_c$	the commanded normal (or lateral) acceleration [ $ft/sec^2$ ] or [ $m/sec^2$ ],
$N$	the navigation constant, a positive real number [dimensionless],
$V_c$	the closing velocity [ $ft/sec$ ] or [ $m/sec$ ],
$\frac{d\lambda}{dt}$	the LOS rate measured by the missile seeker [ $rad/sec$ ].
$R$	range between missile and target,
$v_m$	interceptor missile velocity,
$v_t$	velocity of the target,
$\lambda$	line-of-sight (LOS) angle,
$\gamma_m$	missile flight path (or heading) angle.
$\gamma_t$	target flight path angle.
$PN$	Proportional navigation.
$PD$	Proportional derivative.
$MIMO$	Multiple input multiple output.

# General Introduction

The natural process of improvement of all aspects of our life includes also advances in development of sophisticated weapon systems, the means to defend ourselves from enemies, those who consider wars as a way to improve their living conditions. In lieu of the thrown stone, the cast spear, the flying bullet, the dropping bomb, and the launched rocket, the defensive or destructive functions are better performed by missiles. The fundamental goal of the destruction or defense, destroy the target, has not changed. However, targets became more sophisticated. Technological progress did not avoid them.

In this sense, missile guidance is, in fact, an intriguing and challenging subject that needs the efforts and skills of different engineering disciplines to be aligned and combined for successful system design.

Motivated by the need to develop more efficient and accurate missiles to defend their areas from threats, governments and armies are constantly improving in the development of missile guidance and control system.

In this work, we are interested in investigating a particular guidance problem related to the minimisation of the miss distance and the time of closest approach of a generic surface-to-air missile. To approach towards the solution of such a problem, we design and apply three different guidance laws.

Let us give a brief overview of the topics covered in this thesis, that would also give an idea about the ways in which the thesis is organized.

- **chapter 1** introduces some mathematical background concepts, that allow a better understanding of the mathematical model of missile, its aerodynamic characteristics, and the different methods of control used in this thesis.
- **chapter 2** describes in general terms the missile subsystems and functions. A general idea about the missile classifications and its physical components is given.
- **chapter 3** concerned with the derivation of the mathematical dynamical model of a missile in flight.

- **chapter 4** concerns the representation of aerodynamic data in the form of force and moment coefficients, stability derivatives and the effects of atmospheric properties and of airflow parameters on the aerodynamic forces and moments.
- **chapter 5** describes the important functions and concepts in missile guidance and control system, such as the various types of missile guidances techniques, the different configurations of control system , autopilot, and their models and also the different guidance laws applied in the simulation.
- **chapter 6** presents the simulation chapter where the described missile model is simulated and tested against a moving target with different maneuvers using the different guidance laws cited in the fifth chapter. Then, a qualitative and comparative study between the results is established.

# Chapter 1

## Mathematical background

---

### 1.1 Introduction

Certain physical quantities such as mass, pressure or the absolute temperature at some point only have magnitude. Numbers alone can represent these quantities, with the appropriate units, and they are called scalars. There are, however, other physical quantities that have both magnitude and direction: the magnitude can stretch or shrink and the direction can reverse. These quantities can be added in such a way that takes into account both direction and magnitude. Force is an example of a quantity that acts in a certain direction with some magnitude that we measure in newtons. When two forces act on an object, the sum of the forces depends on both the direction and magnitude of the two forces. Position, displacement, velocity, acceleration, force, momentum and torque are all physical quantities that can be represented mathematically by vectors.

### 1.2 Basic definitions and vector operations

The basic entity in dynamics is a vector. We shall denote vectors by boldface symbols and draw them as arrows. A vector has both magnitude and direction and is represented by magnitudes along any three mutually perpendicular axes, called a coordinate frame (or, a reference frame). Each axis of a coordinate frame is represented by a unit vector, defined as a vector of unit magnitude.

There are two distinct ways in which vectors can be multiplied: **the scalar product** and **the vector product**.

#### 1.2.1 Scalar Product

As the name suggest, the scalar product (also called dot product) of two vectors  $\vec{A}$  and  $\vec{B}$  is a scalar (a quantity with only magnitude), which represents the projection of  $\vec{A}$  onto  $\vec{B}$  multiplied by  $\|\vec{B}\|$ , and is defined as

$$\vec{A} \cdot \vec{B} = \|\vec{A}\| \|\vec{B}\| \cos(\theta) \quad (1.1)$$

Where

$\|\vec{A}\|$  and  $\|\vec{B}\|$  are the magnitudes of the two vectors  $\vec{A}$  and  $\vec{B}$  respectively.  
 $\theta$  is the angle between the two vectors  $\vec{A}$  and  $\vec{B}$ , where  $0 \leq \theta \leq 180$ .

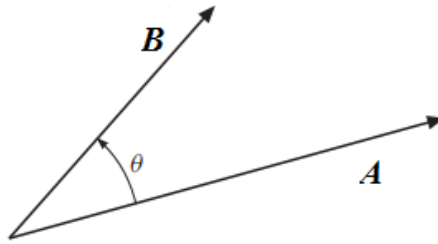

Figure 1.1: The dot product of two vectors A and B.

**Remark:** From this definition, it is clear that the dot product of any two vectors with the same direction is the product of their respective magnitudes, so:

$$\begin{cases} \vec{A} \cdot \vec{i} = A_x \\ \vec{A} \cdot \vec{j} = A_y \\ \vec{A} \cdot \vec{k} = A_z \end{cases} \quad (1.2)$$

**Analytically:** the scalar product can be expressed as the sum of products of the respective components of the two vectors. According to the Eqs (1.2) we can write the dot product of two vectors,  $\vec{A} = A_x\vec{i} + A_y\vec{j} + A_z\vec{k}$  and  $\vec{B} = B_x\vec{i} + B_y\vec{j} + B_z\vec{k}$ , as

$$\vec{A} \cdot \vec{B} = A_x B_x + A_y B_y + A_z B_z \quad (1.3)$$

### 1.2.2 Vector product

The vector product (also called the cross product),  $\vec{A} \times \vec{B}$  is vector, and can be expressed as follows:

$$\vec{A} \times \vec{B} = \|\vec{A}\| \|\vec{B}\| \cos(\theta) \vec{e} \quad (1.4)$$

Where

$\|\vec{A}\|$  and  $\|\vec{B}\|$  are the magnitudes of the two vectors  $\vec{A}$  and  $\vec{B}$  respectively.

$\theta$  is the angle between the two vectors  $\vec{A}$  and  $\vec{B}$ , where  $0 \leq \theta \leq 180$ .

$\vec{e}$  is unit vector, it's direction is normal to the plane formed by the two vectors  $\vec{A}$  and  $\vec{B}$ , and is given by **the right-hand rule** as shown in the following figure:

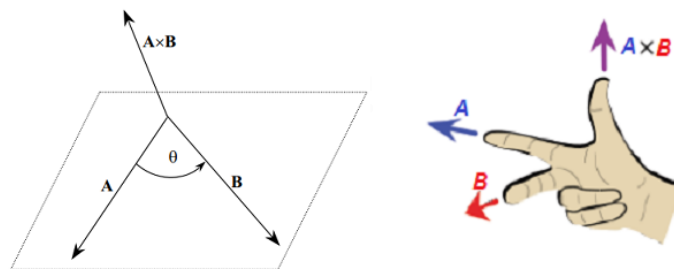

Figure 1.2: Vector product of two vectors A and B.

**Remark:** From this definition, it is clear that the vector product of any two vectors with the same (or opposite) direction is zero, while two mutually perpendicular vectors have a vector product with magnitude equal to the product of their respective magnitudes.

$$\begin{cases} \vec{i} \times \vec{i} = \vec{0} \\ \vec{i} \times \vec{j} = \vec{k} \\ \vec{i} \times \vec{k} = -\vec{j} \end{cases} \quad \begin{cases} \vec{j} \times \vec{i} = -\vec{k} \\ \vec{j} \times \vec{j} = \vec{0} \\ \vec{j} \times \vec{k} = \vec{i} \end{cases} \quad \begin{cases} \vec{k} \times \vec{i} = \vec{j} \\ \vec{k} \times \vec{j} = -\vec{i} \\ \vec{k} \times \vec{k} = \vec{0} \end{cases} \quad (1.5)$$



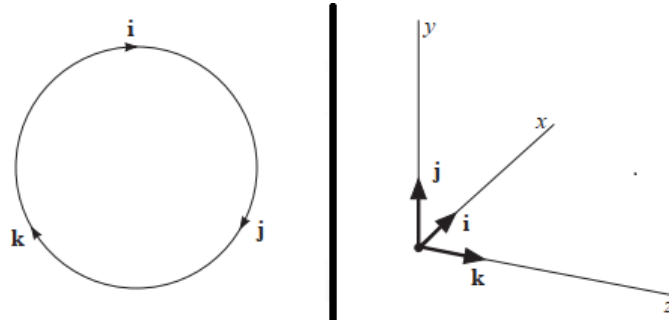

Figure 1.3: The memory circle and reference frame

**Analytical:** the vector product of two vectors,  $\vec{A} = A_x\vec{i} + A_y\vec{j} + A_z\vec{k}$  and  $\vec{B} = B_x\vec{i} + B_y\vec{j} + B_z\vec{k}$  can be expressed as the determinant of a square matrix as :

$$\vec{A} \times \vec{B} = \begin{vmatrix} \vec{i} & \vec{j} & \vec{k} \\ A_x & A_y & A_z \\ B_x & B_y & B_z \end{vmatrix}$$

$$= (A_y B_z - B_y A_z)\vec{i} + (A_z B_x - B_z A_x)\vec{j} + (A_x B_y - B_x A_y)\vec{k} \quad (1.6)$$

### 1.2.2.1 Alternative ways to compute the cross product

The vector cross product also can be expressed as the product of a **skew-symmetric matrix** and a vector as follow :

$$\vec{A} \times \vec{B} = \begin{pmatrix} A_x & A_y & A_z \end{pmatrix} \begin{pmatrix} \vec{i} \\ \vec{j} \\ \vec{k} \end{pmatrix} \times \begin{pmatrix} \vec{i} & \vec{j} & \vec{k} \end{pmatrix} \begin{pmatrix} B_x \\ B_y \\ B_z \end{pmatrix} \quad (1.7)$$

$$= \begin{pmatrix} A_x & A_y & A_z \end{pmatrix} \begin{bmatrix} \vec{i} \times \vec{i} & \vec{i} \times \vec{j} & \vec{i} \times \vec{k} \\ \vec{j} \times \vec{i} & \vec{j} \times \vec{j} & \vec{j} \times \vec{k} \\ \vec{k} \times \vec{i} & \vec{k} \times \vec{j} & \vec{k} \times \vec{k} \end{bmatrix} \begin{pmatrix} B_x \\ B_y \\ B_z \end{pmatrix} \quad (1.8)$$

According to the Eq (1.5) we get:

$$\vec{A} \times \vec{B} = \begin{pmatrix} A_x & A_y & A_z \end{pmatrix} \begin{bmatrix} \vec{0} & \vec{k} & -\vec{j} \\ -\vec{k} & \vec{0} & \vec{i} \\ \vec{j} & -\vec{i} & \vec{0} \end{bmatrix} \begin{pmatrix} B_x \\ B_y \\ B_z \end{pmatrix} \quad (1.9)$$

$$= \begin{pmatrix} \vec{i} & \vec{j} & \vec{k} \end{pmatrix} \begin{bmatrix} \vec{0} & A_z & -A_y \\ -A_z & \vec{0} & A_x \\ A_y & -A_x & \vec{0} \end{bmatrix} \begin{pmatrix} B_x \\ B_y \\ B_z \end{pmatrix} \quad (1.10)$$

$$= \begin{pmatrix} \vec{i} & \vec{j} & \vec{k} \end{pmatrix} \Omega_A \begin{pmatrix} B_x \\ B_y \\ B_z \end{pmatrix} \quad (1.11)$$

Where  $\Omega_A$  is the cross-product operator matrix corresponding to the vector  $\vec{A}$  in reference frame coordinates.

### 1.2.3 Vector triple product

The vector triple product is defined as the cross product of one vector with the cross product of two others. The following relationship holds:

$$\vec{A} \times (\vec{B} \times \vec{C}) = (\vec{A} \cdot \vec{C})\vec{B} - (\vec{A} \cdot \vec{B})\vec{C} \quad (1.12)$$

This relationship known as **the Gibbs rule**.

### 1.2.4 Mixed Triple Product of Three Vectors

The mixed product (or the scalar triple product) is the scalar product of the first vector with the cross product of the other two vectors denoted as :

$$\vec{A} \cdot (\vec{B} \times \vec{C}) \quad (1.13)$$

**Geometrically:** The mixed product is the volume of the parallelepiped defined by vectors  $\vec{A}$ ,  $\vec{B}$  and  $\vec{C}$ , as shown in the following figure:

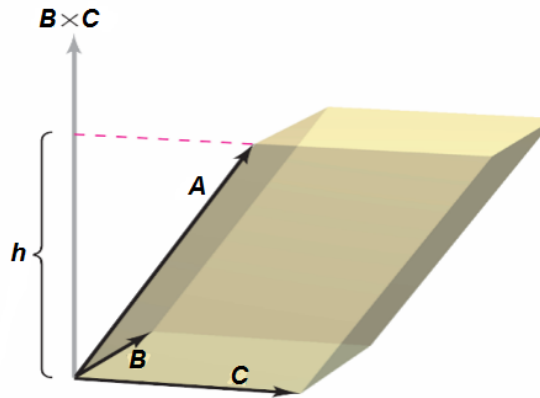

Figure 1.4: Mixed product of three vectors  $\vec{A}$ ,  $\vec{B}$  and  $\vec{C}$

The altitude of the parallelepiped is the projection of the vector  $\vec{A}$  in the direction of the vector  $\vec{B} \times \vec{C}$ , so

$$h = \|\vec{A}\| \cos(\theta) \quad (1.14)$$

Therefore, the scalar product of the vector  $\vec{A}$  and vector  $\vec{B} \times \vec{C}$  is equal to the volume  $V$  of the parallelepiped .

$$\vec{A} \cdot (\vec{B} \times \vec{C}) = \|\vec{B} \times \vec{C}\| \cdot h = V \quad (1.15)$$

**Analytically:** The mixed product can be expressed in terms of the components of the three vectors  $\vec{A} = A_x\vec{i} + A_y\vec{j} + A_z\vec{k}$ ,  $\vec{B} = B_x\vec{i} + B_y\vec{j} + B_z\vec{k}$  and  $\vec{C} = C_x\vec{i} + C_y\vec{j} + C_z\vec{k}$  as the following determinant:

$$\vec{A} \cdot (\vec{B} \times \vec{C}) = \begin{vmatrix} A_x & A_y & A_z \\ B_x & B_y & B_z \\ C_x & C_y & C_z \end{vmatrix} \quad (1.16)$$

$$= A_x(B_y C_z - C_y B_z) + A_y(C_x B_z - B_x C_z) + A_z(B_x C_y - C_x B_y) \quad (1.17)$$

### 1.2.5 Magnitude and direction of a vector

The Cartesian coordinate system defined by  $\vec{i}$ ;  $\vec{j}$ ;  $\vec{k}$  has perpendicular axes. The Pythagorean theorem allows us to calculate the magnitude (length) of a vector given by its components.

Let us consider the vector  $\vec{r} = \vec{A} - \vec{B}$ , the magnitude of vector  $\vec{r}$  is given by :

$$\|\vec{r}\| = \|\vec{A} - \vec{B}\| = \sqrt{(x_A - x_B)^2 + (y_A - y_B)^2 + (z_A - z_B)^2} \quad (1.18)$$

The direction of a vector can be described in one of three closely related ways:

- ★ The unit vector.
- ★ The direction angle.
- ★ The direction cosines.

#### 1.2.5.1 The unit vector

The direction of a vector is most easily described by a unit vector, also called a direction vector. A unit vector, for a particular vector, is parallel to that vector but of unit length. For example, the unit or direction vector corresponding to the vector  $\vec{r}$  can be written as:

$$\vec{u} = \frac{\vec{r}}{\|\vec{r}\|} \quad (1.19)$$

Where

$\vec{u}$  is the unit vector, ( $\|\vec{u}\| = 1$ ).

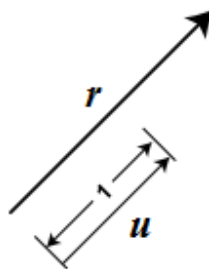

Figure 1.5: Unit vector  $\vec{u}$  of corresponding vector  $\vec{r}$

#### 1.2.5.2 The direction angle

The direction of any directed line segment, or vector  $\vec{r}$ , is specified by the direction angles  $\alpha$ ,  $\beta$  and  $\gamma$ , in the corresponding reference frame, as shown in the following figure:

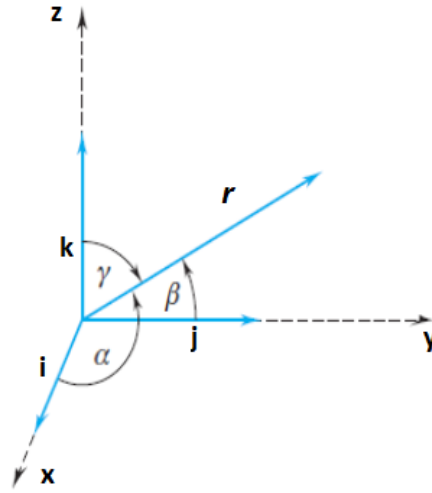

Figure 1.6: Direction angles  $\alpha$ ,  $\beta$  and  $\gamma$  of vector  $\vec{r}$ .

### 1.2.5.3 The direction cosines

The direction cosines are defined as the cosines of the direction angles, namely:

$$a = \cos(\alpha)$$

$$b = \cos(\beta)$$

$$c = \cos(\gamma)$$

With

$$\vec{u} = a\vec{i} + b\vec{j} + c\vec{k}$$

where  $\vec{u}$  is unit vector of the corresponding vector  $\vec{r}$ .

### 1.2.6 Change of basis (Change of frames)

The vectors expressed in one coordinate system frequently must be transformed into a different coordinate system. In particular, assume that the original coordinate system have  $\vec{i}$ ,  $\vec{j}$ , and  $\vec{k}$  as a basis and let  $\vec{a}$  be a vector in the frame  $(o, \vec{i}, \vec{j}, \vec{k})$  represented by the following  $\vec{a} = (a_{x1}\vec{i} + a_{y1}\vec{j} + a_{z1}\vec{k})$ .

We change the basis from  $\vec{i}$ ,  $\vec{j}$ , and  $\vec{k}$  to  $\vec{e}_1$ ,  $\vec{e}_2$  and  $\vec{e}_3$  according to the next consideration

$\vec{e}_1 = \alpha_1\vec{i} + \beta_1\vec{j} + \gamma_1\vec{k}$ ,  $\vec{e}_2 = \alpha_2\vec{i} + \beta_2\vec{j} + \gamma_2\vec{k}$  and  $\vec{e}_3 = \alpha_3\vec{i} + \beta_3\vec{j} + \gamma_3\vec{k}$ . In compact matrix form we can write

$$\begin{bmatrix} \vec{e}_1 \\ \vec{e}_2 \\ \vec{e}_3 \end{bmatrix} = \begin{bmatrix} \alpha_1 & \beta_1 & \gamma_1 \\ \alpha_2 & \beta_2 & \gamma_2 \\ \alpha_3 & \beta_3 & \gamma_3 \end{bmatrix} \begin{bmatrix} \vec{i} \\ \vec{j} \\ \vec{k} \end{bmatrix} \iff [Base]_2 = T[Base]_1 \quad (1.20)$$

We would like to find the coordinates of  $\vec{a}$  in new reference frame with a new basis, but with the same origin:

$$\begin{aligned} \vec{a} &= (a_{x1}\vec{i} + a_{y1}\vec{j} + a_{z1}\vec{k}) = \begin{pmatrix} a_{x2} & a_{y2} & a_{z2} \end{pmatrix} \begin{pmatrix} \vec{e}_1 \\ \vec{e}_2 \\ \vec{e}_3 \end{pmatrix} \\ &= \begin{pmatrix} a_{x2} & a_{y2} & a_{z2} \end{pmatrix} \begin{bmatrix} \alpha_1 & \beta_1 & \gamma_1 \\ \alpha_2 & \beta_2 & \gamma_2 \\ \alpha_3 & \beta_3 & \gamma_3 \end{bmatrix} \begin{bmatrix} \vec{i} \\ \vec{j} \\ \vec{k} \end{bmatrix} \end{aligned} \quad (1.21)$$

$$\begin{pmatrix} a_{x1} \\ a_{y1} \\ a_{z1} \end{pmatrix} = \begin{bmatrix} \alpha_1 & \beta_1 & \gamma_1 \\ \alpha_2 & \beta_2 & \gamma_2 \\ \alpha_3 & \beta_3 & \gamma_3 \end{bmatrix}^T \begin{bmatrix} a_{x2} \\ a_{y2} \\ a_{z2} \end{bmatrix} \iff \begin{pmatrix} a_{x2} \\ a_{y2} \\ a_{z2} \end{pmatrix} = \begin{bmatrix} \alpha_1 & \beta_1 & \gamma_1 \\ \alpha_2 & \beta_2 & \gamma_2 \\ \alpha_3 & \beta_3 & \gamma_3 \end{bmatrix}^{-T} \begin{pmatrix} a_{x1} \\ a_{y1} \\ a_{z1} \end{pmatrix} \quad (1.22)$$

### 1.2.7 Derivative of vectors

The position of a particle is completely described by the function  $r(t)$ . In kinematics we study how this function is related to the variables that control its behaviour, namely the velocity  $v(t)$  and the acceleration  $a(t)$ . In dynamics we are trying to answer the question how the net force acting on the particle at any location  $r(x, y, z)$  governs the behaviour of  $r(t)$ .

Given a vector  $r(t)$  that depends on a parameter of time.

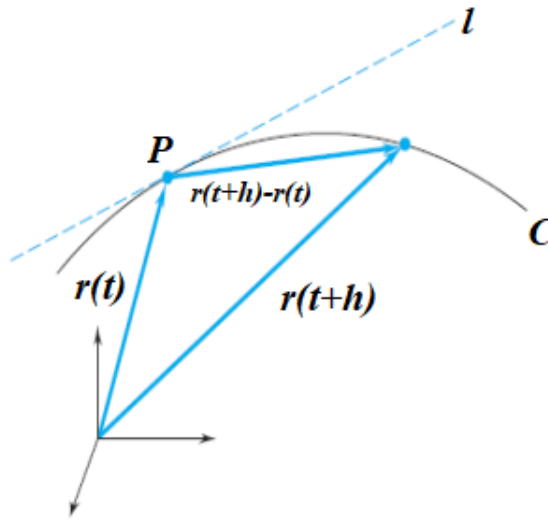

Figure 1.7: The derivative of vector.

If corresponding to each value of a scalar  $t$  we associate a vector  $\vec{r}$ , and then  $\vec{r}$  is called a function of  $t$  denoted by  $\vec{r}(t)$ . In three dimensions we can write  $\vec{r}(t) = x(t)\vec{i} + y(t)\vec{j} + z(t)\vec{k}$ .

The derivative of  $\vec{r}(t)$  is defined as:

$$\frac{d\vec{r}(t)}{dt} = \lim_{h \rightarrow 0} \frac{\vec{r}(t+h) - \vec{r}(t)}{h} \quad (1.23)$$

Where  $h$  is the increment of time.

We can also write the derivative of  $\vec{r}$  in terms of its components such as:

$$\frac{d\vec{r}(t)}{dt} = \frac{dx(t)}{dt}\vec{i} + \frac{dy(t)}{dt}\vec{j} + \frac{dz(t)}{dt}\vec{k} \quad (1.24)$$

- **The velocity** is the first derivative of vector position, and can be written as:

$$\vec{v}(t) = \frac{d\vec{r}(t)}{dt} \quad (1.25)$$

- **The acceleration** is the second derivative of vector position, and can be written as:

$$\vec{a}(t) = \frac{d\vec{v}(t)}{dt} = \frac{d^2\vec{r}(t)}{dt^2} \quad (1.26)$$

### 1.2.8 Differentiation: chain rule

The **Chain Rule** is used when we want to differentiate a function that may be regarded as a composition of one or more simpler functions.

If our function  $f(x) = (g \circ h)(x)$ , where  $g$  and  $h$  are simpler functions, then the Chain Rule may be stated as :

$$f'(x) = (g \circ h)'(x) = (g' \circ h)(x)h'(x) \tag{1.27}$$

There is also another notation which can be easier to work with when using the Chain Rule. Let  $w = f(x, y)$ , where  $f$  is a differentiable function of  $x$  and  $y$  . If  $x = g(t)$  and  $y = h(t)$ , where  $g$  and  $h$  are differentiable function of  $t$ , then  $w$  is a differentiable function of  $t$ , we write it as follows

$$\frac{dw}{dt} = \frac{dw}{dx} \cdot \frac{dx}{dt} + \frac{dw}{dy} \cdot \frac{dy}{dt} \tag{1.28}$$

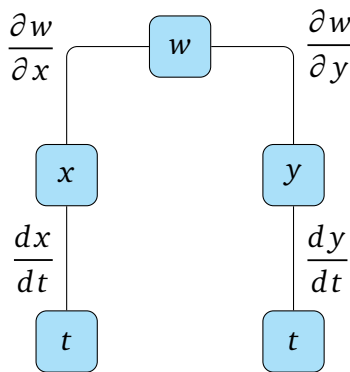

Figure 1.8: Diagram represents the derivative of  $w$  with respect to  $t$

### 1.2.9 Linear momentum

We start with the idea of momentum. The momentum  $p$  of an object is the mass of the object times the velocity of the object:

$$\vec{p}(t) = m\vec{v}(t) = m\vec{r}'(t) = \int \vec{F}(t)dt$$

Assume that the mass of the object is constant. Then differentiation gives

$$\vec{p}'(t) = m\vec{r}''(t) = \vec{F}(t)$$

. Thus, the time derivative of the momentum of an object is the net force on the object:

$\vec{F}(t) = \frac{d(m\vec{v}(t))}{dt}$ . If the net force on an object is continually zero, the momentum  $\vec{p}(t)$  is constant. This is the law of conservation of momentum.

### 1.2.10 Angular momentum

The angular momentum of an object about any given point is a vector quantity that is intended to measure the extent to which the object is circling about that point. If the position of the object at time  $t$  is given by the radius vector  $\vec{r}(t)$ , then the object's angular momentum about the origin is defined by the formula

$$\vec{H}(t) = \vec{r}(t) \times \vec{p}(t) = m\vec{r}(t) \times \vec{v}(t) \tag{1.29}$$

$$\vec{H}(t) = \begin{vmatrix} \vec{i} & \vec{j} & \vec{k} \\ x & y & z \\ mv_x & mv_y & mv_z \end{vmatrix} = m(yv_z - zv_y)\vec{i} + m(zv_x - xv_z)\vec{j} + m(xv_y - yv_x)\vec{k} \quad (1.30)$$

At each time  $t$  of a motion,  $\vec{H}(t)$  is perpendicular to  $\vec{r}(t)$ , perpendicular to  $\vec{v}(t)$ , and directed so that  $\vec{r}(t)$ ,  $\vec{v}(t)$ ,  $\vec{H}(t)$  form a right-handed triple. The magnitude of  $\vec{H}(t)$  is given by the relation

$$\|\vec{H}(t)\| = m\|\vec{r}(t)\| \times \|\vec{v}(t)\| \sin(\theta(t)) \quad (1.31)$$

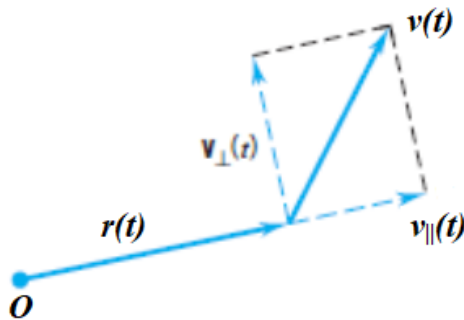

Figure 1.9: The angular momentum

Where  $\theta(t)$  is the angle between  $\vec{r}(t)$  and  $\vec{v}(t)$ . (All this, of course, comes from the definition of the cross product.) If  $\vec{r}(t)$  and  $\vec{v}(t)$  are not zero, then we can express  $\vec{v}(t)$  as a vector parallel to  $\vec{r}(t)$  plus a vector perpendicular to  $\vec{r}(t)$ :

$$\vec{v}(t) = \vec{v}_{\parallel}(t) + \vec{v}_{\perp}(t)$$

$$\vec{H}(t) = m\vec{r}(t) \times (\vec{v}_{\parallel}(t) + \vec{v}_{\perp}(t)) = m\vec{r}(t) \times \vec{v}_{\perp}(t) \quad (1.32)$$

**Remark:** The component of velocity that is parallel to the radius vector contributes nothing to angular momentum. The angular momentum comes entirely from the component of velocity that is perpendicular to the radius vector.

For more details see [14].

# Chapter 2

## Missile system description

---

### 2.1 Introduction

A missile is defined as a space-traversing unmanned vehicle which contains the means for controlling its flight path. A guided missile is considered to operate only above the surface of the Earth, and can be controlled in flight till interception to achieve destruction of the target. While guided missiles have become more and more sophisticated and smart, the fundamentals of missiles remain unchanged. A host of different disciplines of science and engineering go into the making of a guided missile system. This chapter gives a bird's eye view of the different types of guided missile systems, and the components, which go to make up a guided missile system[4].

### 2.2 Classification of missiles

The missiles are classified by the physical areas of launching and the physical areas containing the target. The four general categories of the guided missiles are:

- (1) Surface-to-surface missile
- (2) Surface-to-air missile
- (3) Air-to-surface missile
- (4) Air-to-air missile

Surface-to-Surface missiles and Air-to-Surface missiles are operated from an air or land platform toward a surface target. However, the surface-to-air and Air-to-air missiles are operated toward an air target.

Surface-to-air missile systems are designed to meet specified operational requirements. The variety of requirements leads to different missile sizes and fictional arrangements. Many of the differences among missile systems are the results of variations in tracking implementations and guidance concepts. The purpose of a surface-to-air missile system is to destroy threatening airborne targets. The system includes the missile flight vehicle and supportive equipment such as a launcher, any ground-based missile and/or target trackers, and any ground-based guidance processors.

Guided missiles may also be classified as strategic or tactical, with further subdivisions depending on the role. Strategic missiles are large missiles, often with nuclear warheads and very long ranges, meant to destroy the enemy's ability to wage war. Tactical missiles, on the other hand, are meant for



battlefield use for the limited purpose of winning the battle or encounter. These can be of different kinds, depending on their roles[4].

## 2.3 Missile components

A guided missile is typically divided into four subsystems: the airframe, guidance, motor (or propulsion), and warhead[1].

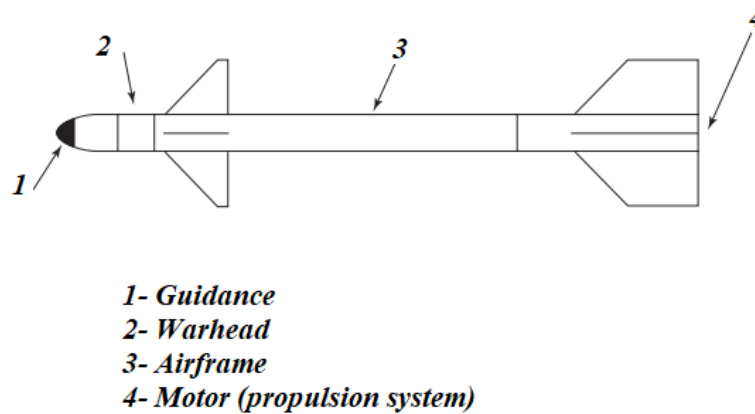

Figure 2.1: Missile components

These subsystems(components) will now be examined in more detail:

### 2.3.1 Seeker

A missile seeker is composed of a **seeker head** to collect and detect energy from the target, a **tracking function** to keep the seeker boresight axis pointed toward the target and a **processing function** to extract useful information from the detection and tracking circuits. The following figure shows a real seeker head.

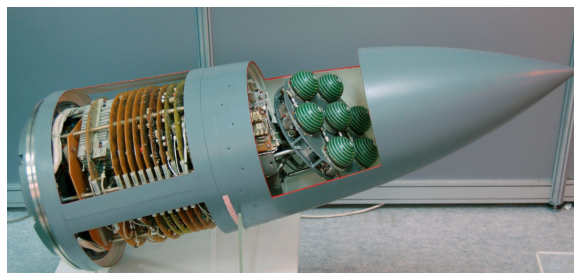

Figure 2.2: Seeker head configuration

The seeker usually is mounted in the nose of the missile where it can have an unobstructed view ahead. The seeker antenna or optical system is usually mounted on gimbals to permit its central viewing direction (boresight axis) to be rotated in both azimuth and elevation relative to the missile centerline .

<sup>0</sup>Fig 2.2 Avtomatika L-112E anti-radiation seeker.

The **gimballed portion** of the seeker head usually is stabilized to keep it pointing in a fixed direction regardless of perturbing angular motions of the missile body. The two most prevalent means of stabilization are to spin a portion of the gimballed components so that they act as a **gyro** and to use actuators to hold the seeker in a stabilized direction using control signals from gyros mounted on the gimbal frames. In either case, signals from the tracking circuitry are required to change the pointing direction of the seeker. The two gimbal angles are the azimuth ( $\psi$ ) and elevation ( $\theta$ ) angles, which are defined in the same manner as the Euler angles. The x-axis indicates the line-of-sight (LOS) direction.

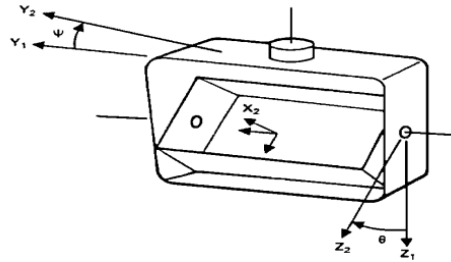

Figure 2.3: Seeker gimbal

The two common seeker types are **optical** and **radio frequency (RF)** seeker.

### 2.3.1.1 Optical seekers

Seekers that sense radiation in the ultraviolet(UV), visual, and infrared (IR) portions of the electromagnetic spectrum are classed as optical seekers. The radiation is transmitted through the atmosphere from the target. Not all target radiation. Optical radiation is attenuated by the geometrical distance from the source (inverse range squared); by absorption and scattering by the atmosphere; by clouds, haze, rain, and snow, and by other obscuring agents such as smoke and dust. The amount of attenuation is influenced by the wavelength of the radiation.

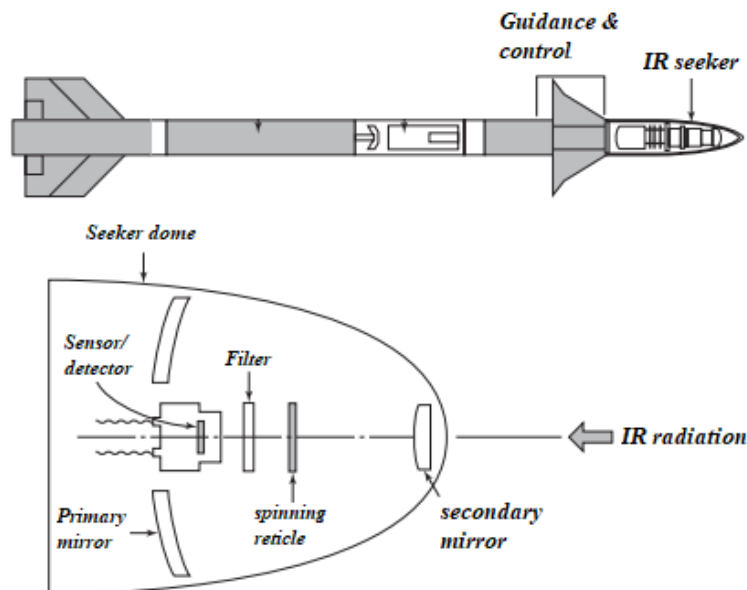

Figure 2.4: Generic IR seeker and its location in missile

There are three types of optical seekers based on the different techniques used to process the optical image. These methods are **reticle**, **pseudoimaging**, and **imaging**.

### 2.3.1.2 Radio Frequency Seekers

An RF seeker is essentially a radar in which the antenna is employed to collect RF radiation reflected from the target. The RF power may be generated by systems onboard the target, by a target illuminator on the ground or by a transmitter onboard the missile.

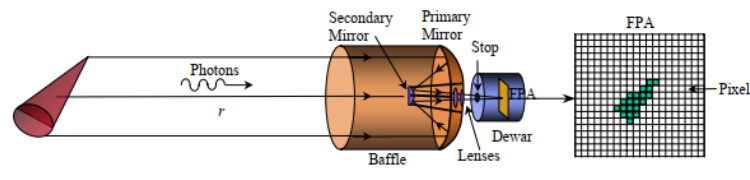

Figure 2.5: Radio frequency seeker

- **Passive RF seeker** receives radiation generated by the target.



Figure 2.6: Passive seeker

- **Semiactive seeker** receives reflected target echoes of radiation originally generated by a ground-based illuminator.

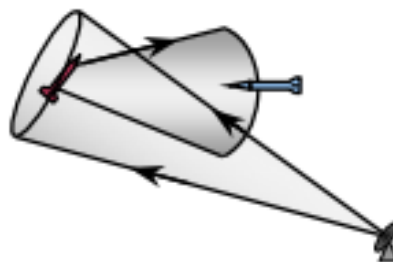

Figure 2.7: Semi-active seeker

- **Active seeker** receives target echoes of radiation originally generated and transmitted from onboard the missile.

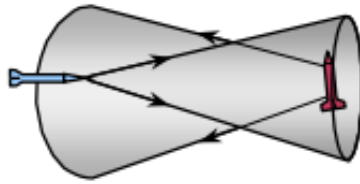

Figure 2.8: Active seeker

The basic radar types applicable to surface-to-air missiles are **pulse radars**, **continuous wave (CW) radars**, and **pulse Doppler radars**.

### 2.3.2 Autopilot

The autopilot in a missile serves as a "*translator*" between the guidance processor and the control system.

### 2.3.3 Control system

A system that serves to maintain attitude stability of the missile and to correct deflections[5]. See chapter 5 for more details.

### 2.3.4 Guidance system

A system which evaluates flight information, correlates it with target data, determines the desired flight path of a missile, and communicates the necessary commands to the missile flight control system[5]. See also chapter 5.

### 2.3.5 Warhead

The warhead is the reason-for-being of any service guided missile. It may be designed to inflict any of several possible kinds of damage on the enemy. The other components are intended merely to ensure that the warhead will reach its destination.

The types of warheads that might be used with guided missiles include: external blast, fragmentation, shaped-charge, explosive-pellet, chemical, biological, nuclear, continuous rod, clustered, thermal, illuminating, psychological, and dummy. Some types of warheads which are used in surface to air missile will be discussed in the following paragraphs.

#### 2.3.5.1 Shaped Charge

This warhead is composed of many shaped charges directed radially outward from the centerline of the missile. Each shaped charge expels hypervelocity particles of a metallic liner into a very narrow, concentrated beam. The extremely high velocity of the fragments adds another damage mechanism, called the vaporific effect, which resembles the effect of an explosion occurring inside the target structure. Inspection of structures damaged by this mechanism shows aircraft skins peeled outward rather than the inward deformation that would be typical of slower fragments and external blast. In addition, between the shaped-charge spokes are areas of enhanced external blast effects, which reach to much greater ranges than blast effects from isotropic warheads.

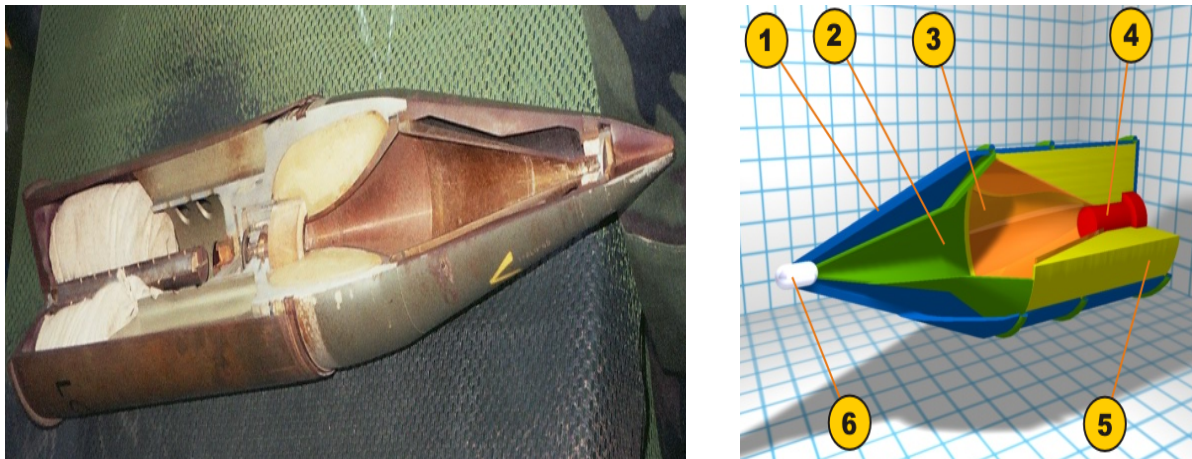

Figure 2.9: Shaped charge warhead and its implimentation in 3D

1. Aerodynamic cover.
2. Air filled cavity.
3. Conical liner.
4. Detonator.
5. Explosive.

### 2.3.5.2 Continuous Rod

Continuous rod warheads are designed with a cylindrical casing composed of a double layer of steel rods. The rods are welded in such a way that each end of a rod is connected to an end of a neighboring rod. As the rods are blown out radially by the explosion, they hang together forming a continuous circle. The objective of the continuous rod warhead is to cut long slices of target skins and stringers and thus weaken the structure to the point at which aerodynamic loads will destroy it. When the continuous ring of rods reaches its maximum diameter, it breaks up, and the lethality drops off markedly.



Figure 2.10: Continuous rod warhead explosion test

<sup>0</sup>Image 2.10: Arena firing of continuous-rod warhead, 1972 at Naval Air Weapons Station China Lake.

### 2.3.5.3 Fragment

Most surface-to-air missiles use blast-fragment warheads. Although damage is caused primarily by the fragments, a bonus is obtained from coincident blast effects if the miss distance is small enough. The approximately cylindrical metal warhead casing is fabricated by scoring or other means so that the explosion of the charge breaks the casing into many discrete fragments of uniform shape and size. These fragments fly out radially, approximately perpendicular to the centerline of the missile, and form a circular band of fragments that expands in diameter. Fragments are not very effective in causing target structural damage except at close miss distances at which a high density of fragments can be applied. Fragments are very effective, however, against target components such as a pilot, fuel cells, wiring, plumbing, electronic control equipment, electronic armament equipment, and engine peripheral equipment.

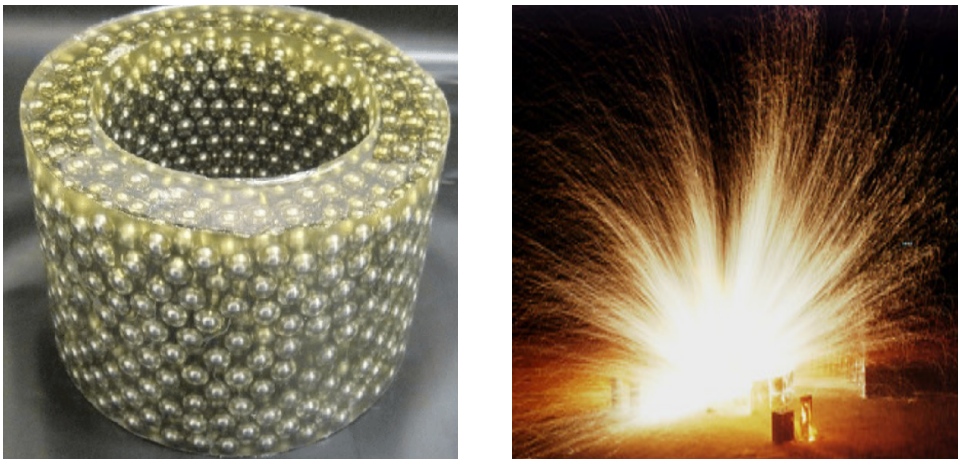

Figure 2.11: Fragments warhead and its explosion test

### 2.3.6 Fuze

The guided missile fuze may be defined as that device which causes the warhead to detonate in such a position that maximum damage will be inflicted on an average target. For most guided missiles the guidance accuracy is such that the missile will not always actually impact the target but will usually pass close to it. Near misses can be converted to successful intercepts by the use of proximity fuzes that sense the approach of the missile to the target and initiate a warhead detonation command. Most surface-to-air missiles contain two fuzes an **impact fuze** that is triggered by impact with the target and a **proximity fuze** that is triggered by a close approach to the target.

#### 2.3.6.1 Impact fuze

An impact fuze is one that is actuated by inertial force that occurs when missile strikes the target. For example, consider a cylindrical tube located in a warhead with a shock-sensitive explosive percussion charge permanently fixed in the forward end of the tube (relative to the direction of flight) and a heavy metallic plunger at the rear end of the tube, as shown in the following figure[6].

<sup>0</sup>Fig 2.11: Preformed fragments (the type of metal) in the matrix cured polymer (Widener et al., 2012).

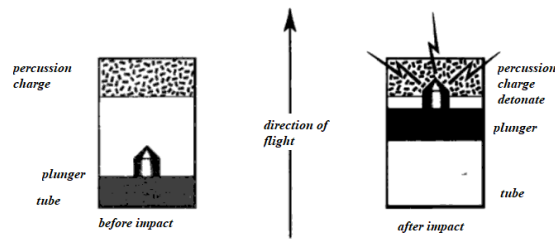

Figure 2.12: Impact fuze before and after impact

While in flight, the movable plunger remains against the rear end of the tube. However, when the missile comes to a sudden stop against the target, the plunger, tending to remain in motion, rushes to the forward end of the tube where it strikes and detonates the shock-sensitive fuze charge. The fuze charge in turn detonates the bursting charge of the warhead. The right diagram illustrates the position of the plunger after the target has been engaged.



Figure 2.13: Impact fuze

### 2.3.6.2 Proximity Fuze

Proximity fuzes, often called VT (variable time) fuzes, are actuated by some characteristic feature of target or target area. Listed below are some basic proximity fuzes:

- a. Photoelectric proximity fuzes
- b. Acoustic proximity fuzes
- c. Pressure proximity fuzes
- d. Radio proximity fuzes
- e. Electrostatic proximity fuzes.

Each of these fuzes is preset to function when the intensity of the target characteristic, or target area characteristic, to which that fuze is sensitive, reaches a certain magnitude. Proximity fuzes are designed so that the warhead burst pattern will occur at the most effective time and location relative to the target. Adapting the proximity fuzes to the burst pattern of warhead is, in general, difficult since the burst pattern is influenced by the relative velocity with which the missile approaches the target. If targets with widely varying speeds are to be attacked, it may be possible to automatically adjust the fuze sensitivity on the basis of the target speed as predicted by a computer.

Proximity fuzes activate the auxiliary warhead detonating system after electrically integrating two factors:

- (1) nearness to the target,
- (2) rate of approach to the target.

However, if the target succeeds in jamming a proximity fuze, only a direct hit can be effective[6].



Figure 2.14: Proximity fuze

### 2.3.7 Airframe

The Airframe is the cylindrical tube structure that carries the warhead to the target, and houses all the missile subsystems, attached end-to-end, and supports the control fins, stabilizing fins, and wings (if any). The method of control influences the airframe configuration. Configurations with canard control, tail control, and wing control. Airframe deflection (aeroelastic effect) is an important consideration in missile design.

The front end (nose) of the missile is usually a radome or optical dome to house the seeker. Radomes, housing RF seekers, have pointed noses to minimize drag under supersonic flow conditions. Optical domes, housing optical seekers, are usually hemispherical to avoid optical ray diffraction, and the contribution to drag is acceptable because they can be made small. The rocket nozzle exit usually forms the tail end of the airframe, and there are usually stabilizing fins located near the tail to provide static stability.

The missile must be as light and compact as possible, yet strong enough to carry the warhead. (and other components), and withstand the forces to which it will be subjected, such as gravity, air pressure, winds, heat, stresses of acceleration and deceleration, and other forces. For every pound of weight saved in the missile structure, less propulsion energy is required. The weight and balance relationships must be given careful consideration. The initial location of the center of gravity is of extreme importance. The center of gravity can change during missile flight because of the burning of the propellant, and separation of the booster after burnout. These factors and others must be carefully included in the calculations of the missile designers to produce a structure that will perform as expected.

### 2.3.8 Propulsion system

This system provides the energy required to move the missile from the launcher to the target. There are two basic types of jet propulsion power plants used in missile propulsion systems **the atmospheric (airbreathing) jet** and **the thermal jet propulsion systems**. The basic difference between the two systems is that the atmospheric jet engine depends on the atmosphere to supply the oxygen necessary to start and sustain burning of the fuel. The thermal jet engine operates independently



of the atmosphere by starting and sustaining combustion with its own supply of oxygen contained within the missile.

### 2.3.8.1 Atmospheric jet propulsion system

Any jet-propelled system that obtains oxygen from the surrounding atmosphere to support the combustion of its fuel is an atmospheric jet engine. **Pulsejets**, **ramjets** and **turbojets**, are all of this type, although the latter are not used in guided missiles. Obviously, the operation of these engines is limited by the amount of oxygen available, and they can operate only at altitudes where the oxygen content of the air is adequate.

- **Pulsejet:** Pulsejet engines are so called because of the intermittent or pulsating combustion process. A pulsejet engine can be made with few or no moving parts and is capable of running statically. Pulsejet engines are a lightweight form of jet propulsion, but usually have a poor compression ratio, and hence give a low specific impulse. Although pulsejet engines were used by the U.S. Navy to propel an early missile, they are now considered obsolete[6].



Figure 2.15: Pulsejet engine

- **Ramjet:** A ramjet engine derives its name from the ram action that makes its operation possible. (This engine is sometimes referred to as the athodyd, meaning aerothermodynamic duct). It is the simplest of the air-breathing propulsion engines, and has no moving parts. Ramjet operation is limited to altitudes below about 90,000 feet because atmospheric oxygen is necessary for combustion.

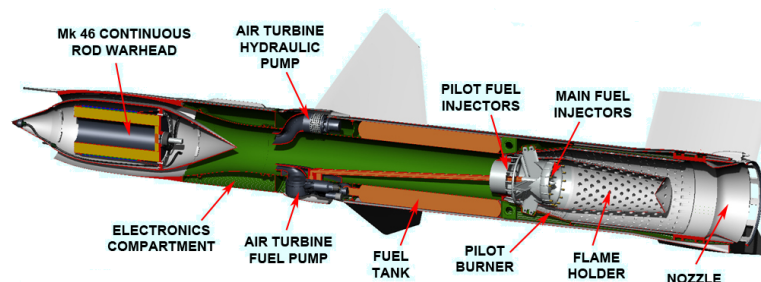

Figure 2.16: Ramjet engine

- **Turbojet:** A turbojet engine is an air-dependent thermal jet-propulsion device. It derives its name from the fact, that its compressor is driven by a turbine wheel, which is itself driven by the exhaust gases. A typical turbojet engine includes an air intake, a mechanical compressor driven by a turbine, a combustion chamber, and an exhaust nozzle.

<sup>0</sup>Image 2.15: The Loon (Argus) pulse jet demonstrated at the Planes of Fame Air Museum.

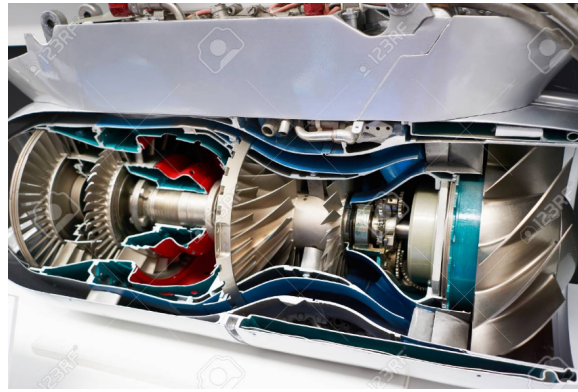

Figure 2.17: Turbojet engine

Turbojets may be divided into two types depending on the type of compressor. These are centrifugal-flow turbojets and axial-flow turbojets.

The engine does not require boosting and can begin operation at zero acceleration.

### 2.3.8.2 Thermal jet propulsion system

Thermal jets include solid propellant, liquid propellant, and combined propellant systems. An AO comes in contact with all three systems. The solid propellant and combined propellant systems are currently being used in some air-launched guided missiles[14].

- **Liquid propellant:** Liquid propellant rocket motors use a liquid fuel and a liquid oxidizer—each carried onboard in separate containers. The propellants are metered into a combustion chamber in which high-temperature; high-pressure gases are generated and exhausted through a nozzle to produce thrust. [14].

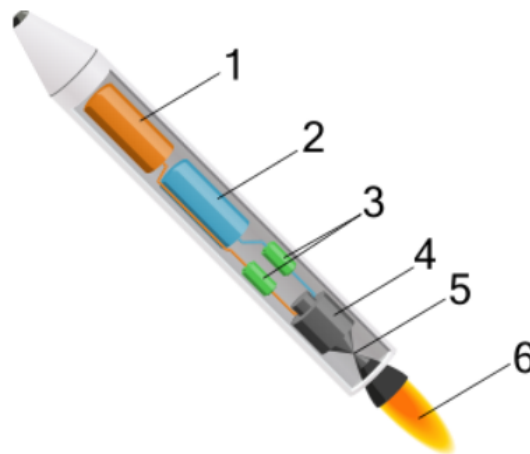

Figure 2.18: A simplified liquid propellant rocket

- 1)-Liquid rocket fuel.
- 2)-Oxidizer.
- 3)-Pumps carrying the fuel and oxidizer.
- 4)-The combustion chamber mixes and burns the two liquids.
- 5)-The hot exhaust is choked at the throat.
- 6)-Exhaust exits the rocket.

- **Solid propellant** :A solid-propellant rocket or solid rocket is a rocket with a rocket engine that uses solid propellants (fuel/oxidizer). The earliest rockets were solid-fuel rockets powered by gunpowder; they were used in warfare by the Chinese, Indians, Mongols and Persians, as early as the 13th century. A simple solid rocket motor consists of a casing, nozzle, grain (propellant charge), and igniter[14].



Figure 2.19: A simplified solid propellant rocket

- 1)- A solid fuel-oxidizer mixture (propellant) is packed into the rocket, with a cylindrical hole in the middle.
- 2)- An igniter combusts the surface of the propellant.
- 3)- The cylindrical hole in the propellant acts as a combustion chamber.
- 4)- The hot exhaust is choked at the throat.
- 5 )- Exhaust exits the rocket.

In some guided missiles, different thrust requirements exist during the boost phase as compared to those of the sustaining phase. The dual thrust rocket motor (DTRM) is a combined system that contains both of these elements in one motor. The DTRM contains a single propellant grain made of two types of solid propellant—boost and sustaining. The grain is configured so the propellant meeting the requirements for the boost phase burns at a faster rate than the propellant for the sustaining phase. After the boost phase propellant burns itself out, the sustaining propellant sustains the motor in flight over the designed burning time (range of the missile).

- **Combined propellant** : A hybrid engine consists of a liquid oxidizer, a solid fuel, and its associated hardware. The liquid oxidizer is valved into a chamber containing the solid propellant. Ignition is usually hypergolic. Neither of the propellants will support combustion by itself in a true hybrid rocket. The combustion chamber is within the solid grain, as in a solid-fuel rocket; the liquid portion is in a tank with pumping elements as in a liquid-fuel rocket. This type is sometimes called a forward hybrid to distinguish it from a reverse hybrid, in which the oxidizer is solid and the fuel is liquid. The biggest advantage of hybrids is the ability to use reactions denied to other propulsion systems. A second advantage is that high density can be achieved, with concurrently good specific impulse. The third great advantage is safety.

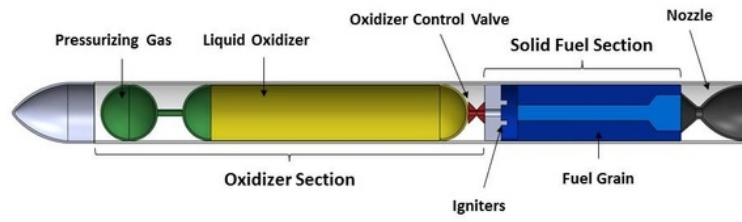

Figure 2.20: Combined propellant

# Chapter 3

## Mathematical modeling of a missile

---

### 3.1 Introduction

Missile models are based on mathematical equations that describe the dynamic motions of missiles that result from the forces and moments acting upon them. The mathematical tools employed are the equations of motion, which describe the relationships between the forces acting on the missile and the resulting missile motion. Three-degree-of-freedom models employ translational equations of motion; six-degree-of-freedom models employ, in addition, rotational equations of motion. The inputs to the equations of motion are the forces and moments acting on the missile; the outputs are the missile accelerations that result from the applied forces and moments.

### 3.2 Forces and moments

The forces and moments are produced by aerodynamics, propulsion, and gravity. Aerodynamic forces and moments are generated by the flow of air past the missile; they depend on the missile speed, configuration, and attitude, as well as on the properties of the ambient air. Propulsive thrust is usually designed to act through the missile center of mass and thus produces no moment about the center of mass.

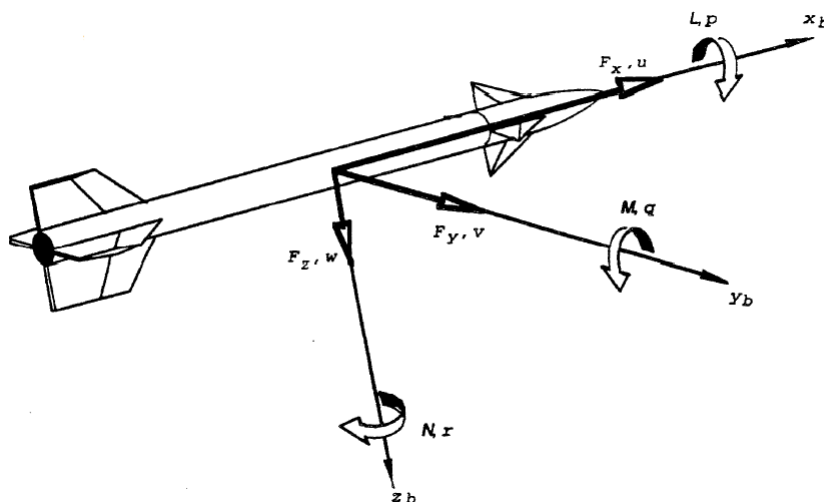

Figure 3.1: Forces, Velocities, Moments, and Angular Rates in Body Reference Frame

### 3.2.1 Aerodynamic forces and moments

The magnitudes of aerodynamic forces and moments depend on ambient air conditions and on missile configuration, attitude, and speed. Missile configuration includes the configuration of the body plus any fixed fins and the control surfaces. If the missile and surrounding air mass are considered components of a single closed system the forces that develop between the air and the missile produce equal but opposite changes in the momentums of the two systems; thus the momentum of the total system is conserved in conformance with Newton's laws.

#### 3.2.1.1 Aerodynamic forces

The resultant aerodynamic force  $F_A$  on the missile can be resolved in any coordinate frame to give three orthogonal components. Often the most convenient reference frame for calculating aerodynamic forces is the wind coordinate system  $(x_w, y_w, z_w)$ . As shown in figure 3.2, the total angle of attack  $\alpha_t$ , and the resultant aerodynamic force  $F_A$  lie on the  $x_w z_w$ -plane, and there is no side force and no sideslip angle  $\beta$  in this system. The component of  $F_A$  on the  $x_w$ -axis is called the drag force  $D$ , and the component on the  $z_w$ -axis is called the lift force  $L$ . The term "lift" implies a force directed upward to oppose the force due to gravity; however, in missile aerodynamics lift is applied in whatever direction is needed to control the flight path of the air vehicle.

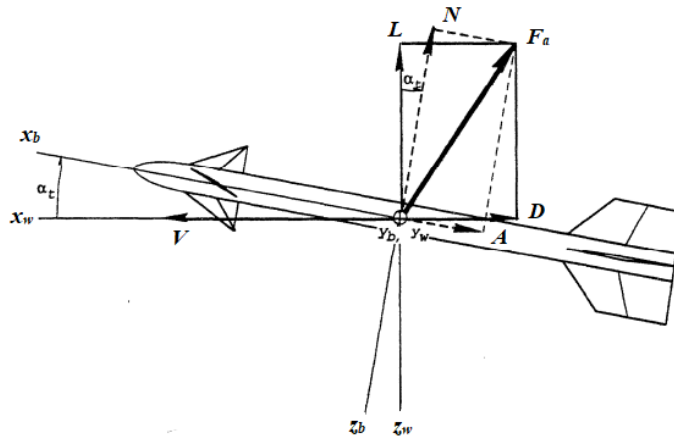

Figure 3.2: Aerodynamic Force in Body and Wind-Frame Coordinates

If aerodynamic forces are calculated in the wind system, they must be transformed to the body system for use in equations expressed in the body system. When  $F_A$  is expressed in the body system, its component on the  $x_b$ -axis is called the axial force  $A$  (parallel with the missile longitudinal axis, as shown in figure 3.2). The component on the  $z_b$ -axis is called the normal force  $N$  (normal to the missile longitudinal axis).

The lift  $L$  and drag  $D$  can be transformed to the normal force  $N$  and axial force  $A$  by:

$$A = D \cos \alpha_t - L \sin \alpha_t \quad (3.1)$$

$$N = D \sin \alpha_t + L \cos \alpha_t \quad (3.2)$$

Where

$A$  = magnitude of aerodynamic axial force vector,

$D$  = magnitude of aerodynamic drag force vector,

$L$  = magnitude of aerodynamic lift force vector,

$N$  = magnitude of aerodynamic normal force vector,

$\alpha_t$  = the total angle of attack.

### 3.2.1.2 Aerodynamic moments

The magnitude of the moment is equal to the product of the resultant aerodynamic force and a lever arm defined as the perpendicular distance from the resultant aerodynamic force vector to the center of mass of the missile. If aerodynamic moments are calculated in other than the body reference frame, they are transformed to it. The components in the body frame of the vector representing the sum of all aerodynamic moments are  $L_A$ ,  $M_A$ , and  $N_A$  along the  $x_b$ ,  $y_b$ , and  $z_b$  axes, respectively.

## 3.2.2 Propulsion forces and moments

### 3.2.2.1 Thrust force

The total thrust produced by a rocket motor is composed of two parts, **the momentum thrust** and **the pressure thrust**. As the rocket propellant burns, the products of combustion are exhausted through the rocket nozzle at high velocity. The force that propels these exhaust gases has an equal and opposite reaction on the missile.

- **The momentum thrust:** The momentum imparted to the gases in the rearward direction is balanced by the momentum imparted to the missile in the forward direction and thus conserves the momentum within the closed system. The portion of the total thrust attributed to this momentum change has magnitude  $\dot{m}eV_{re}$  where  $\dot{m}e$  is the mass rate of flow of the exhaust gases (more details later) and  $V_{re}$  is the velocity of the exhaust gases relative to the missile.
- **The pressure thrust:** The average pressure  $p_e$  of the expanding exhaust gases at the exit plane of the rocket nozzle acts over the exit area  $A_e$  of the rocket nozzle. The remainder of the missile is surrounded by the ambient atmospheric pressure  $p_a$ . This imbalance of pressure constitutes the pressure thrust, which has magnitude  $(p_e - p_a)A_e$ .

Combining the two thrust portions in vector form, the total thrust force on the missile is given by:

$$F_p = F_{momentum} + F_{pressure} = \dot{m}eV_{re} + (p_e - p_a)A_e(u_{ve}) \quad (3.3)$$

Where

$A_e$  = rocket nozzle exit area

$F_p$  = total instantaneous thrust force vector

$\dot{m}e$  = mass rate of flow of exhaust gas ( $\dot{m}e = -\dot{m}$ )

$p_a$  = ambient atmospheric pressure

$p_e$  = average pressure across rocket nozzle exit area

$u_{ve}$  = unit vector in direction of relative exhaust velocity  $V_{re}$

$V_{re}$  = velocity vector of expelled exhaust gas relative to center of mass of missile

#### ► VARIABLE MASS:

A frequent error in the application of Newton's equations of motion to systems with variable mass is to assume that the rate of change of linear momentum is given by

$$F_{ext} = \frac{d(mv)}{dt} = m\dot{v} + \dot{m}v \quad (\text{Wrong}) \quad (3.4)$$

Where

$F_{ext}$  = vector sum of forces acting on the missile

$m$  = instantaneous mass of missile (includes mass of unburned propellant)

$\dot{m}$  = rate of change of missile mass  $m$

$v$  = absolute linear velocity vector of missile

$\dot{v}$  = absolute acceleration vector of center of mass of missile

The correct rate of change of momentum of the system must take into account the fact that not all mass particles in the system have the same velocity. In the case of a missile, the missile itself (including unburned propellant) has absolute velocity  $V$ , and the exhaust gases have absolute velocity  $V_e$  or relative velocity  $V_{re}$  with respect to the center of mass of the missile.

In order to employ Newton's second law, the system under consideration must be defined as one of constant mass. This is accomplished by assuming a total, closed system that consists of the missile flight vehicle plus the rocket exhaust gases expelled during an incremental time interval  $\Delta t$ .

Although this total, closed system has constant mass, parts of the system have an interchange of mass. During the time interval  $\Delta t$  the missile body mass is reduced by the mass of the expelled gases  $\Delta m_e$ . At the end of the time interval, the mass of the missile is  $(m - \Delta m_e)$ , the mass of the ejected gases is  $\Delta m_e$ , and the momentum acquired by the gases is equal and opposite to the momentum acquired by the missile. The momentum thus acquired by the missile is due to the momentum component of thrust.

In the absence of forces external to this total, closed system, the overall momentum of the system would be conserved. However, in reality, external forces are applied to the system, and the resulting change in momentum is given by

$$F_{ext} = \frac{dP}{dt} \quad (3.5)$$

Where

$F_{ext}$  = vector sum of external forces applied to the total system

$P$  = linear momentum vector of the total system

Since the momentum component of thrust is developed internally to the total system, as defined, it does not contribute to the forces  $F_{ext}$ . For a missile the external forces  $F_{ext}$  consist of aerodynamic forces, the pressure component of thrust, and gravity. These external forces are applied directly to the missile body; therefore, they affect only the portion of the total system momentum attributable to the missile. For rocket motors operating within the atmosphere, atmospheric interactions cause external forces to be applied also to the exhaust gases; however, these forces do not affect the missile and therefore can be disregarded.

From Eq (3.5) an appropriate result for the time interval  $\Delta t$  can be written as

$$F_{ext} = \frac{\Delta P}{\Delta t} = \frac{P_f - P_i}{\Delta t} \quad (3.6)$$

Where

$P_i$  = initial total system momentum at beginning of time interval

$P_f$  = final total system momentum at end of time interval

The values of the momentum of the total system at the beginning and end of the time interval are given by

$$\begin{cases} P_i = mv \\ P_f = (m - \Delta m_e)(v + \Delta v) + \Delta m_e v_e \end{cases} \quad (3.7)$$

Where

$m$  = missile mass at beginning of time interval



$\Delta m_e$  = mass of exhaust gases expelled from missile during time interval  
 $v$  = absolute velocity of missile at beginning of time interval  
 $\Delta v$  = change in missile velocity during time interval  
 $v_e$  = absolute velocity of exhaust gases

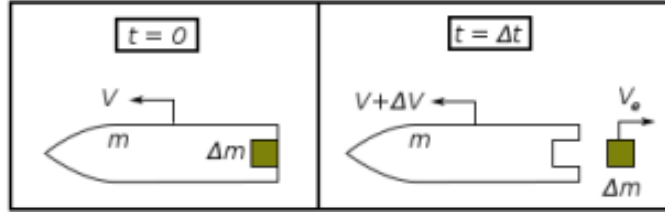

Figure 3.3: Mass variation

Substitution of Eqs (3.7) into Eq (3.6) gives

$$F_{ext} = \frac{(m - \Delta m_e)(v + \Delta v) + \Delta m_e v_e - mv}{\Delta t} \quad (3.8)$$

If  $\Delta t$  approaches zero, i.e  $\Delta t \rightarrow 0$ , then

$$\frac{\Delta v}{\Delta t} \rightarrow \frac{dv}{dt} = \dot{v}, \quad \frac{\Delta m_e}{\Delta t} \rightarrow \frac{dm_e}{dt} = \dot{m}_e, \quad \frac{\Delta m_e \Delta v}{\Delta t} \rightarrow 0$$

This will lead to the next result

$$F_{ext} = m\dot{v} + (v_e - v)\dot{m}_e \quad (3.9)$$

Letting  $v_{re} = v_e - v$  gives

$$F_{ext} = m\dot{v} + v_{re}\dot{m}_e \quad (3.10)$$

This is known as **Meshchersky equation** for variable mass system.

Where

$F_{ext}$  = vector of sum of external forces applied to the total system

$m$  = missile mass at beginning of time interval

$\dot{m}_e$  = mass rate of flow of exhaust gas

$\dot{v}$  = absolute acceleration vector of center of mass of a body

$v_{re}$  = velocity vector of expelled exhaust gas relative to center of mass of missile

As previously stated the vector sum of forces external to the total, closed system  $F_{ext}$  consists of the aerodynamic force  $F_A$ , the pressure force  $(p_e - p_a)A_e(-u_{ve})$ , and the gravitational force  $F_g$ .

$$F_A - v_{re}\dot{m}_e + (p_e - p_a)A_e(-u_{ve}) + F_g = m\dot{v} \quad (3.11)$$

Where

$A_e$  = rocket nozzle exit area

$F_A$  = resultant aerodynamic force vector

$F_g$  = gravitational force vector including effects of earth rotation

$m$  = instantaneous mass of a particle or body

$\dot{m}$  = mass rate of flow of exhaust gas

$p_a$  = ambient atmospheric pressure

$p_e$  = average pressure across rocket nozzle exit area

$u_{ve}$  = unit vector in direction of relative exhaust velocity

$\dot{v}$  = absolute acceleration vector of center of mass of a body

$v_{re}$  = velocity vector of expelled exhaust gas relative to center of mass of missile

Substituting the definition of  $F_p$ , which includes both the pressure and momentum components of thrust, into this last equation, gives:

$$F_A + F_p + F_g = m\dot{v} \quad (3.12)$$

Finally, setting  $F_{ext}$  equal to the sum of forces  $F_A + F_p + F_g$  acting directly on the missile allows one to write

$$F_{ext} = m\dot{v} \quad (3.13)$$

This is known as the Newton's second law .

Finally, the rate of change of mass, which was used incorrectly in Eq (3.4) has been correctly absorbed into the momentum component of thrust. Thus it is shown that a missile with a rocket motor is analyzed in the same way as any problem having constant mass except that the value of  $m$  to be used in Eq (3.11) is a function of time[14].

### 3.2.2.2 Thrust moment

If the thrust vector  $F_p$  passes through the center of mass of the missile, no rotational moment is generated by the thrust. When the thrust vector does not pass through the center of mass, either by design or error, the resulting moment on the missile is equal to the product of the magnitude of the thrust and the perpendicular distance between the thrust vector and the center of mass. The components in the body frame of the vector representing the propulsion moment are  $L_p$ ,  $M_p$ , and  $N_p$  along the  $x_b$ ,  $y_b$ , and  $z_b$  axes, respectively.

## 3.2.3 Gravitational force

The force of gravity observed on the earth is the result of two physical effects **the Newtonian gravitational mass attraction and the rotation of the earth about its axis.**

### 3.2.3.1 Newtonian Gravitation

The law of gravitation, defined by Newton, that governs the mutual attraction between bodies is

$$F_G = \frac{Gm_1m_2}{R_{cm}^2} \quad (3.14)$$

Where

$F_G$  = magnitude of the mutual force of gravitational mass attraction between two masses

$G$  = universal gravitational constant,  $6.673 \times 10^{-11} m^3 / (kg - s^2)$

$m_1, m_2$  = masses of bodies, kg

$R_{cm}$  = distance between centers of masses of two bodies

Gravitational attraction is exerted on a missile by all planets, stars, the moon, and the sun. It is a force that pulls the vehicle in the direction of the center of mass of the attracting body. Within the immediate vicinity of the earth, the attraction of the other planets and bodies is negligible compared to the gravitational force of the earth.

In the absence of forces other than gravity, all objects, regardless of mass, that are allowed to fall at a given position on the earth will have the same acceleration  $A_g$ . This can be seen by combining

Eqs (3.13) and (3.14) and canceling the term representing the mass of the falling object. This combination gives

$$A_g = \frac{Gm_{earth}}{R_{cm}^2} (u_{R_{cm}}) \quad (3.15)$$

where

$A_g$  = acceleration vector due to gravitational mass attraction between earth and a free-falling object

$G$  = universal gravitational constant,  $6.673 * 10^{-11} m^3 / (kg - s^2)$

$m_{earth}$  = mass of earth,  $5.977 * 10^{24} kg$

$R_{cm}$  = distance from earth center to body mass center

$u_{R_{cm}}$  = unit vector directed from center of earth toward body

### 3.2.3.2 Gravity in Rotating Earth Frame

The acceleration calculated by Eq (3.15) is the acceleration of a body that would be measured with respect to an inertial reference frame; therefore,  $A_g$  can be written as :

$$A_g = A_{rot} + w_e \times (w_e \times R_e) \quad (3.16)$$

Taking  $A_{rot} = g_0$  then:

$$g_0 = A_g - w_e \times (w_e \times R_e) \quad (3.17)$$

Where

$A_g$  = acceleration vector due to gravitational mass attraction between earth and a free falling object

$g_0$  = vector of acceleration due to gravity at earth surface

$R_e$  = radius vector from earth center to point on earth surface

$w_e$  = absolute (sidereal) angular rate of the earth

The gravitational force acts at the center of gravity of the missile and, hence, does not produce any moments. Further, when specifying this term and other altitude dependent terms, distinction must be made between the spherical earth and the flat earth cases in the equations of motion. Surface-to-air missile simulations, however, usually are based on the assumption of a flat, nonrotating earth. In this case the motion of the missile relative to the earth is best approximated by employing the gravitational acceleration  $g$  which is given by

$$g = g_0 \left[ \frac{R_e^2}{(R_e + h)^2} \right] \quad (3.18)$$

where

$g$  = magnitude of acceleration-due-to-gravity vector  $g$

$g_0$  = magnitude of the acceleration due to gravity at the earth surface vector  $g_0$

$h$  = altitude above sea level

$R_e$  = radius of the earth

Gravitational force  $F_g$  is calculated by substituting the acceleration due to gravity into Newton's equation:

$$F_g = mg. \quad (3.19)$$

where

$F_g$  = magnitude of gravitational force vector  $Fg$

$g$  = magnitude of acceleration-due-to-gravity vector  $g$

$m$  = mass of the body.

The term  $F_g$  is commonly called the weight of the object and is directed locally downward.

### 3.3 Motion of rigid body on fixed point

We have in polar coordinates:  $\vec{h} = h\vec{i}_r$ , with  $\vec{i}_r = \cos(\theta)\vec{i} + \sin(\theta)\vec{j}$ , notice that  $\vec{i}_r$  is time varying don't change magnitude, but its direction will change with time when the body is rotating about  $z$  axis. As it is known in classical mechanics a moving vector  $\vec{h}$  has a speed equal to the derivative of its position[27].

$$\vec{V}_h = \frac{d\vec{h}}{dt} = \frac{dh}{dt}\vec{i}_r + h\frac{d\vec{i}_r}{dt} \quad (3.20)$$

$$\frac{d\vec{i}_r}{dt} = \frac{d\theta}{dt}(-\sin(\theta)\vec{i} + \cos(\theta)\vec{j}) = \frac{d\theta}{dt}\vec{i}_\theta \quad (3.21)$$

The scalar quantities  $h, z_r$  are constant with respect to time, means that  $\vec{r}(t) = h\vec{i}_r + z_r\vec{k}$

$$\vec{V}(t) = \frac{d\vec{r}(t)}{dt} = \frac{dh}{dt}\vec{i}_r + h\frac{d\vec{i}_r}{dt} + z_r\frac{d\vec{k}}{dt} \quad (3.22)$$

with

$$\frac{dh}{dt} = \frac{dz_r}{dt} = 0 \quad (3.23)$$

and

$$\frac{d\vec{k}}{dt} = \vec{0}$$

$$\vec{V}(t) = \frac{d\vec{r}(t)}{dt} = h\frac{d\theta}{dt}\vec{i}_\theta(-\sin(\theta)\vec{i} + \cos(\theta)\vec{j}) \quad (3.24)$$

From the projection of the vector  $\vec{r}$  in the Cartesian coordinate we obtain the following components:  $x_r = h \cos(\theta)$ ,  $y_r = h \sin(\theta)$ ,  $z_r = r \cos(\phi)$  and  $h = r \sin(\phi)$  then we can write:

$$x_r = r \sin(\phi) \cos(\theta)$$

$$y_r = r \sin(\phi) \sin(\theta)$$

$$z_r = r \cos(\phi)$$

Using the following well-known cross products of the unite vectors  $\vec{i} \times \vec{j} = \vec{k}$ ,  $\vec{j} \times \vec{k} = \vec{i}$ ,  $\vec{k} \times \vec{i} = \vec{j}$ ,  $\vec{k} \times \vec{k} = \vec{0}$  and  $x_r, y_r, z_r$  in the velocity equation we get:

$$\vec{V}(t) = h\frac{d\theta}{dt} \left( \frac{y_r}{h}\vec{k} \times \vec{j} + \frac{x_r}{h}\vec{k} \times \vec{i} + \frac{z_r}{h}\vec{k} \times \vec{k} \right) \quad (3.25)$$

$$\vec{V}(t) = \left( h\frac{d\theta}{dt}\vec{k} \right) \left( \frac{y_r}{h}\vec{j} + \frac{x_r}{h}\vec{i} + \frac{z_r}{h}\vec{k} \right) \quad (3.26)$$

$$\vec{V}(t) = \left( \frac{d\theta}{dt}\vec{k} \right) \times \vec{r}(t) \quad (3.27)$$

$$\vec{V}(t) = \vec{\omega} \times \vec{r}(t) \quad (3.28)$$

**Remark**

- We notice that the velocity vector for any point  $M$  of a body is equal to the vector product of the angular velocity of that body and the radius vector of the point.  $\vec{V}(t) = \vec{\omega} \times \vec{r}(t)$ .

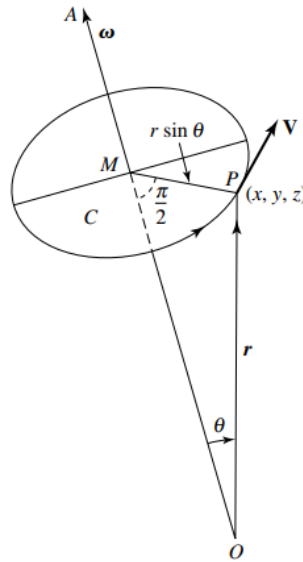

Figure 3.4: General rigid body with angular velocity vector  $\omega$  about its center of mass.

- In order to calculate the derivative of some rotating unit vectors  $\vec{i}$ ,  $\vec{j}$ ,  $\vec{k}$  we assume that is the radius of vector  $\vec{r}_M = \vec{i}$  of a point  $M$  on the axis  $x$  at unit distance from the origin. Then

$$\frac{d\vec{i}}{dt} = \frac{d\vec{r}_M}{dt} = V_M(t) \quad (3.29)$$

But according to the velocity vector equation,  $\vec{V}_M = \vec{\omega} \times \vec{r}_M = \vec{\omega} \times \vec{i}$ , where  $\vec{\omega}$  is the angular velocity of the rotation about axis  $OZ$ . Similar relationships are obtained for the derivatives of  $\vec{j}$  and  $\vec{k}$ , and finally we obtain the following equations which are known as the **Poisson equations** :

$$\frac{d\vec{i}}{dt} = \vec{\omega} \times \vec{i} \quad , \quad \frac{d\vec{j}}{dt} = \vec{\omega} \times \vec{j} \quad , \quad \frac{d\vec{k}}{dt} = \vec{\omega} \times \vec{k}$$

### 3.4 The general motion of a rigid body in space

The general motion of a body can be described by the translation of the center of mass and the rotation of the body about its center of mass. In order to solve the newton's second law, one must know  $r(t)$  (the vector position) for all the particles constituting the body that describing the relative motion of the particles with respect to the center of mass, be obtained by integrating additional differential equations in time. Such equations of relative motion are obtained by taking into account the internal forces acting on the individual particles. However, if the body is rigid, the relative distances of all particles with respect to the center of mass are fixed. The translational and rotational motions can be studied separately, provided the net force and moment vectors do not depend

upon the rotational and translational motions, respectively. For an atmospheric flight vehicle, the aerodynamic force depends upon the vehicle's attitude (rotational variables), and aerodynamic and thrust moments depend upon the speed and altitude (translational variables); thus, the two motions are inherently coupled. However, when the time scale of rotation is much smaller than that of translation, then, the two can effectively be decoupled. In such a case, the instantaneous rotational parameters are treated as inputs to the translatory motion, and the position and velocity are treated as almost constant parameters for the rotational motion. But in our case The decoupling of rotational and translational motions may not be a good approximation for a high-performance missile, or an aircraft.

We can summarize it in this equation :

### General motion = Translation motion + Rotaional motion

So we Consider a fixed system  $(ox_e y_e z_e)$ , assumed to be the inertial frame and another rotating system  $(ox_b y_b z_b)$ , assumed to be the body's fixed frame, which rotate with respect to the first one by an angular velocity  $\vec{\omega}$ . Let  $\vec{i}$ ,  $\vec{j}$ , and  $\vec{k}$  be a unit vectors along the axes of the rotating system. Let  $\vec{V}$  be an arbitrary vector with components  $V_x, V_y$  and  $V_z$  along the rotating axes. Then:

$$\left(\frac{d\vec{V}}{dt}\right)_I = \left(\frac{dV_x}{dt}\vec{i} + \frac{dV_y}{dt}\vec{j} + \frac{dV_z}{dt}\vec{k}\right) + V_x \frac{d\vec{i}}{dt} + V_y \frac{d\vec{j}}{dt} + V_z \frac{d\vec{k}}{dt} \quad (3.30)$$

$$\left(\frac{d\vec{V}}{dt}\right)_I = \left(\frac{d\vec{V}}{dt}\right)_B + V_x \frac{d\vec{i}}{dt} + V_y \frac{d\vec{j}}{dt} + V_z \frac{d\vec{k}}{dt} \quad (3.31)$$

$$\left(\frac{d\vec{V}}{dt}\right)_I = \left(\frac{d\vec{V}}{dt}\right)_B + \vec{\omega} \times (V_x \vec{i} + V_y \vec{j} + V_z \vec{k}) \quad (3.32)$$

$$\left(\frac{d\vec{V}}{dt}\right)_I = \left(\frac{d\vec{V}}{dt}\right)_B + \vec{\omega} \times \vec{V} \quad (3.33)$$

## 3.5 Equations of motion

The equations of motion are obtained from Newton's second law, which states that the summation of all external forces acting on a body is equal to the time rate of the momentum of the body, and the summation of the external moments acting on the body is equal to the time rate of change of angular momentum. Specifically, Newton's laws of motion were formulated for a single particle[14]. Assuming that the mass  $m$  of the particle is multiplied by its velocity  $V$ , then the product

$$P = mV. \quad (3.34)$$

is called the linear momentum (vector quantity). For a system of  $n$  particles, the linear momentum is the summation of the linear momentum of all particles in the system. Thus:

$$P = \sum_{i=1}^n (m_i V_i) = m_1 V_1 + m_2 V_2 + \dots + m_n V_n. \quad (3.35)$$

Mathematically, Newton's second law can be expressed in terms of conservation of both linear and angular momentum by the following vector equations:

$$\text{Translation : } \quad \sum F_{ext} = \left[ \frac{d(mV)}{dt} \right]_I \quad (3.36)$$

$$\text{Rotation : } \quad \sum M = \left[ \frac{dH}{dt} \right]_I \quad (3.37)$$

where  $F_{ext}$  represent the external forces,  $m$  is the mass,  $V$  is the linear velocity of the missile,  $H$  the angular momentum, and the symbol  $I$  indicates the time rate of change of the vector  $\dot{H}$  with respect to inertial frame.

### 3.5.1 Translational equations

The basis of the translational equations of motion is the second Newton's laws ( $F = m \frac{dV}{dt}$ ) where: it is understood from the discussion before, that  $F$  includes the sum of the external forces-aerodynamic, pressure thrust, and gravitational and the internally generated momentum thrust and that the variable mass has been correctly taken into account. In a missile flight simulation the usual procedure used to solve the translational equation of motion, is to calculate the summation of forces  $F$  based on aerodynamic, propulsive, and gravitational data, substitute  $F$  into the equation of motion, gives :

$$\sum F_{ext} = m \left( \frac{dV}{dt} \right)_I \quad (3.38)$$

In general, when the derivative (or incremental change) of a vector is calculated using components in a given reference frame, the resulting rate of change of the vector is relative to that particular reference frame. If that reference frame is not an inertial one, the rate of change is not an absolute one as required by Newton's laws. So a mathematical procedure is required to convert the rate-of-change vector to one that is relative to an inertial frame, which known as the general motion of rigid body in space.

$$\left( \frac{d\vec{V}}{dt} \right)_I = \left( \frac{d\vec{V}}{dt} \right)_B + (\vec{\omega} \times \vec{V}) \quad (3.39)$$

we substitute this equation in the second Newton's laws, we obtain:

$$\sum \vec{F}_{ext} = m \left[ \left( \frac{d\vec{V}}{dt} \right)_B + (\vec{\omega} \times \vec{V}) \right] \quad (3.40)$$

The linear velocity of the missile  $V$  can be broken up into components  $u$ ,  $v$ , and  $w$  along the missile  $(x_b, y_b, z_b)$  body axes, respectively. Mathematically, we can write the missile vector velocity  $V$ , in terms of the components as:

$$\vec{V} = u\vec{i}_b + v\vec{j}_b + w\vec{k}_b \quad (3.41)$$

where  $(i_b, j_b, k_b)$  are the unit vectors along the respective missile body axes.

In a similar manner, the missile's angular velocity vector  $\omega$  can be broken up into the components  $p$ ,  $q$ , and  $r$  about the  $(x_b, y_b, z_b)$  axes, respectively, as follows:

$$\vec{\omega} = p\vec{i}_b + q\vec{j}_b + r\vec{k}_b \quad (3.42)$$

where  $p$  is the roll rate,  $q$  is the pitch rate, and  $r$  is the yaw rate.

The first part on the right-hand side of Eq (3.39) can be written as :

$$\frac{d\vec{V}}{dt} = \left(\frac{du}{dt}\right)\vec{i}_b + \left(\frac{dv}{dt}\right)\vec{j}_b + \left(\frac{dw}{dt}\right)\vec{k}_b \quad (3.43)$$

where

$\left(\frac{du}{dt}\right)$  = the longitudinal acceleration.

$\left(\frac{dv}{dt}\right)$  = the lateral acceleration.

$\left(\frac{dw}{dt}\right)$  = the vertical acceleration.

The second part on the right-hand side of Eq (3.39) which is the cross product of vectors  $\vec{\omega}$  and  $\vec{V}$  can be written as:

$$\vec{\omega} \times \vec{V} = \begin{bmatrix} \vec{i}_b & \vec{j}_b & \vec{k}_b \\ p & q & r \\ u & v & w \end{bmatrix} = (qw - rv)\vec{i}_b + (ru - pw)\vec{j}_b + (pv - qu)\vec{k}_b \quad (3.44)$$

next, we can write the sum of external forces as :

$$\sum F_{ext} \vec{e}_i = \sum F_x \vec{i}_b + \sum F_y \vec{j}_b + \sum F_z \vec{k}_b \quad (3.45)$$

such that :

$$\sum F_{ext} = F_A + F_p + F_g \quad (3.46)$$

Where  $F_A$  represent the aerodynamic force,  $F_p$  is the propulsion force and  $F_g$  is the gravitational force.

Equating the components of Eqs (3.43), (3.44), and (3.45) yields the missile's linear equations of motion. Thus

$$\begin{cases} \sum F_x = m(\dot{u} + qw - rv) \\ \sum F_y = m(\dot{v} + ru - pw) \\ \sum F_z = m(\dot{w} + pv - qu) \end{cases} \quad (3.47)$$

Substituting the components of Eq (1.46) in (1.47) and rearrange the equations using the necessary operations we obtain the final translation equations of missile model, thus

$$\begin{cases} \dot{u} = \frac{(F_{Ax} + F_{px} + F_{gx})}{m} - (qw - rv) \\ \dot{v} = \frac{(F_{Ay} + F_{py} + F_{gy})}{m} - (ru - pw) \\ \dot{w} = \frac{(F_{Az} + F_{pz} + F_{gz})}{m} - (pv - qu) \end{cases} \quad (3.48)$$

Where

$F_{Ax}, F_{Ay}, F_{Az}$  = components of aerodynamic force vector  $F_A$  expressed in the body coordinate system  
 $F_{px}, F_{py}, F_{pz}$  = components of propulsive force vector  $F_p$  expressed in the body coordinate system



$F_{gx}, F_{gy}, F_{gz}$  = components of gravitational force vector  $F_g$  expressed in the body coordinate system  
 $m$  = instantaneous missile mass  
 $p, q, r$  = components of angular rate vector  $\omega$  expressed in the body coordinate system, (roll, pitch and yaw, respectively)  
 $u, v, w$  = components of absolute linear velocity vector  $V$  expressed in the body coordinate system  
 $\dot{u}, \dot{v}, \dot{w}$  = components of linear acceleration expressed in the body coordinate system

### 3.5.2 Rotational equations

The rotational motion of a vehicle is important for various reasons (aerodynamics, pointing of weapons, payload, or antennas, etc.) and governs the instantaneous attitude (orientation). It was evident that the instantaneous attitude depends not only upon the rotational kinematics, but also on rotational dynamics which determine how the attitude parameters change with time for a specified angular velocity.

The basis of the rotational equation of motion is Eq (3.37), so in a similar manner as the translation motion we can obtain the equations of angular motion. However, before we develop these equations, an expression for the angular momentum  $H$  is needed to this end.

If we consider a missile to be rigid body which is constituting by a collection of particles of elemental mass  $\delta m$ , and  $V$  the velocity of the elemental mass relative to the inertial frame, and  $\delta F$  the resulting force acting on the elementa mass. So from Newton's second law we have:

$$\delta F = \delta m \frac{dV}{dt} \quad (3.49)$$

The total external force acting on the missile is found by summing all the elements of the missile. Therefore,

$$\sum \delta F = F. \quad (3.50)$$

The velocity of the differential mass  $\delta m$  is :  $\vec{V} = \vec{v}_c + \frac{d\vec{r}}{dt}$  with  $\vec{v}_c$  is the velocity of the center of mass of the missile and  $\frac{d\vec{r}}{dt}$  is the velocity of the element relative to center of mass.

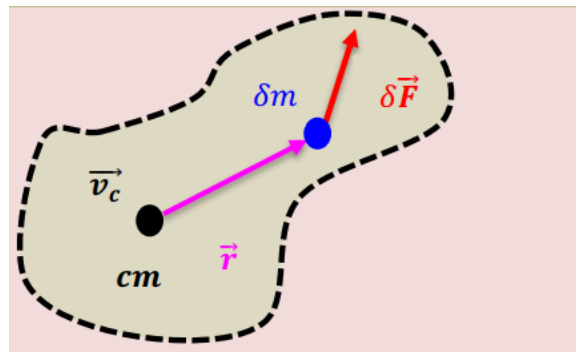

Figure 3.5: The relative position vector

$$\vec{F} = \sum \delta \vec{F} = \frac{d}{dt} \sum \left( \vec{v}_c + \frac{d\vec{r}}{dt} \right) \delta m \quad (3.51)$$

$$= m \frac{d\vec{v}_c}{dt} + \frac{d}{dt} \sum \frac{d\vec{r}}{dt} \delta m \quad (3.52)$$

$$= m \frac{d\vec{v}_c}{dt} + \frac{d^2}{dt^2} \sum \vec{r} \delta m. \quad (3.53)$$

Because  $\vec{r}$  is measured from the center of mass then  $\sum \vec{r} \delta m = 0$  and therefore we get:

$$\vec{F} = m \frac{d\vec{v}_c}{dt}. \quad (3.54)$$

Similarly, we can develop the moment equation referred to a moving center of mass. For the differential element of mass,  $\delta m$ , the moment equation can be written as:

$$\sum \delta \vec{M} = \frac{d\vec{H}}{dt} = \frac{d}{dt} (\vec{r} \times \vec{V}) \delta m \quad (3.55)$$

with

$$\sum \delta \vec{M} = \vec{M}.$$

The velocity of the mass element can be expressed in terms of the velocity of the center of the mass and relative velocity,

$$\vec{V} = \vec{v}_c + \frac{d\vec{r}}{dt} = \vec{v}_c + \vec{\omega} \times \vec{r} \quad (3.56)$$

Where  $\vec{\omega}$  is the angular velocity of the rigid body and  $\vec{r}$  is the position of the mass element measured from the center of mass.

From Eqs (3.55) and (3.56) the total momentum can be written as:

$$\vec{H} = \sum \delta \vec{H} = \sum \delta m \vec{r} \times \vec{v}_c + \sum [\vec{r} \times (\vec{\omega} \times \vec{r})] \delta m \quad (3.57)$$

we know that  $\sum \vec{r} \delta m = 0$  then :

$$\vec{H} = \sum [\vec{r} \times (\vec{\omega} \times \vec{r})] \delta m \quad (3.58)$$

Let define the the components of the angular velocity, the position of the mass element measured from the center of mass, and the total momentum expressed in the body coordinate system respectively:

$$\vec{\omega} = p\vec{i}_b + q\vec{j}_b + r\vec{k}_b, \quad \vec{r} = x\vec{i}_b + y\vec{j}_b + z\vec{k}_b, \quad \vec{H} = H_x\vec{i}_b + H_y\vec{j}_b + H_z\vec{k}_b,$$

We know that

$$\vec{\omega} \times \vec{r} = \begin{bmatrix} \vec{i}_b & \vec{j}_b & \vec{k}_b \\ p & q & r \\ x & y & z \end{bmatrix} = (qz - ry)\vec{i}_b + (rx - pz)\vec{j}_b + (py - qx)\vec{k}_b \quad (3.59)$$

so we obtain

$$\begin{aligned} \vec{r} \times (\vec{\omega} \times \vec{r}) &= \begin{bmatrix} \vec{i}_b & \vec{j}_b & \vec{k}_b \\ x & y & z \\ (qz - ry) & (rx - pz) & (py - qx) \end{bmatrix} \\ &= [(y^2 + z^2)p - xyq - xzr]\vec{i}_b + [(z^2 + x^2)q - xyp - yzr]\vec{j}_b + [(x^2 + y^2)r - xzp - yzq]\vec{k}_b \end{aligned} \quad (3.60)$$

we have

$$\vec{H} = \sum [\vec{r} \times (\vec{\omega} \times \vec{r})] \delta m = \sum -[\vec{r} \times (\vec{r} \times \vec{\omega})] \delta m \quad (3.61)$$

then

$$\vec{H} = \sum -(\vec{r} \times [\Omega_r] \vec{\omega}) \delta m = \sum ([\Omega_r] \vec{\omega} \times \vec{r}) \delta m \quad (3.62)$$

$$\vec{H} = \sum ([\Omega_r] [\Omega_r]^T \vec{\omega}) \delta m \quad (3.63)$$

we know from chapter 1:

$$[\Omega_r] = \begin{bmatrix} 0 & -z & y \\ z & 0 & -x \\ -y & x & 0 \end{bmatrix} \quad (3.64)$$

and

$$[\Omega_r]^T = -[\Omega_r] \quad (3.65)$$

so the product of Eq (3.64) and (3.65) is given by:

$$[\Omega_r][\Omega_r]^T = \begin{bmatrix} (y^2 + z^2) & -xy & -xz \\ -xy & (x^2 + z^2) & -yz \\ -xz & -yz & (x^2 + y^2) \end{bmatrix} \quad (3.66)$$

so the angular momentum vector can be written as:

$$\vec{H} = [I]\vec{\omega} \quad (3.67)$$

where

$$[I] = \begin{bmatrix} I_{xx} & -I_{xy} & -I_{xz} \\ -I_{xy} & I_{yy} & -I_{yz} \\ -I_{xz} & -I_{yz} & I_{zz} \end{bmatrix} = \int [\Omega_r][\Omega_r]^T \delta m \quad (3.68)$$

This matrix is called the inertia matrix (or the inertia tensor).

where

$$\begin{aligned} I_{xx} &= \int (y^2 + z^2) dm, & I_{xy} &= \int (xy) dm \\ I_{yy} &= \int (x^2 + z^2) dm, & I_{xz} &= \int (xz) dm \\ I_{zz} &= \int (x^2 + y^2) dm, & I_{yz} &= \int (yz) dm \end{aligned}$$

and

$x$ ,  $y$  and  $z$  are coordinates of infinitesimal masses  $\delta m$  of the body.

$I_{xx}$ ,  $I_{yy}$  and  $I_{zz}$  are the moments of inertia.

$I_{xy}$ ,  $I_{xz}$  and  $I_{yz}$  are the products of inertia.

Due to the assumption that the given missile has a cruciform symmetry i.e the product of inertia  $I_{xy} = I_{xz} = I_{yz} = 0$  and  $I_{yy} = I_{zz}$ , so the inertia matrix can be simplified as :

$$[I] = \begin{bmatrix} I_{xx} & 0 & 0 \\ 0 & I_{yy} & 0 \\ 0 & 0 & I_{zz} \end{bmatrix} \quad (3.69)$$

from the Eq (3.67) the angular momentum can be written as :

$$\vec{H} = [I]\vec{\omega} = \begin{pmatrix} I_{xx} & 0 & 0 \\ 0 & I_{yy} & 0 \\ 0 & 0 & I_{zz} \end{pmatrix} \begin{pmatrix} p \\ q \\ r \end{pmatrix} \quad (3.70)$$

Now we must determine the derivative of the vector  $\vec{H}$  referred to the rotating body frame of reference, therefore:

$$\left(\frac{d\vec{H}}{dt}\right)_I = \left(\frac{d\vec{H}}{dt}\right)_B + \vec{\omega} \times \vec{H} \quad (3.71)$$

substituting Eq (3.70) in (3.37) we obtain :

$$\sum \vec{M} = \left(\frac{d\vec{H}}{dt}\right)_B + \vec{\omega} \times \vec{H} \quad (3.72)$$

where the left-hand side of Eq (3.72) which is the summation of the external moments act on the missile is given by:

$$\sum \vec{M} = \sum L\vec{i}_b + \sum M\vec{j}_b + \sum N\vec{k}_b \quad (3.73)$$

where  $L$  ,  $M$  and  $N$  are components of total moment vector  $\vec{M}$  expressed in body coordinate system (roll, pitch, and yaw, respectively)

The first part on the right-hand side of Eq (3.72) expressed in the body reference frame can be written as :

$$\left(\frac{d\vec{H}}{dt}\right)_B = \frac{dH_x}{dt}\vec{i}_b + \frac{dH_y}{dt}\vec{j}_b + \frac{dH_z}{dt}\vec{k}_b \quad (3.74)$$

and

$$\begin{cases} \frac{dH_x}{dt} = \frac{dp}{dt}I_{xx} \\ \frac{dH_y}{dt} = \frac{dq}{dt}I_{yy} \\ \frac{dH_z}{dt} = \frac{dr}{dt}I_{zz} \end{cases} \quad (3.75)$$

where

$H_x$  ,  $H_y$  ,  $H_z$  = the components of the angular momentum.

$p$  ,  $q$  ,  $r$  = the components of the angular velocity, along the  $x_b$ ,  $y_b$ ,  $z_b$  axes of the body reference frame, respectively.

$I_{xx}$ ,  $I_{yy}$  ,  $I_{zz}$  = the components of diagonal inertia matrix  $[I]$ .

The second part on the right-hand side of Eq (3.72) which is the cross-product of the angular velocity  $\vec{\omega}$  and the angular momentum  $\vec{H}$  expressed in the body reference frame is given by :

$$\vec{\omega} \times \vec{H} = \begin{bmatrix} \vec{i}_b & \vec{j}_b & \vec{k}_b \\ p & q & r \\ H_x & H_y & H_z \end{bmatrix} = (qH_z - rH_y)\vec{i}_b + (rH_x - pH_z)\vec{j}_b + (pH_y - qH_x)\vec{k}_b \quad (3.76)$$

we have

$$\begin{cases} H_x = pI_{xx}, \\ H_y = qI_{yy}, \\ H_z = rI_{zz}. \end{cases} \quad (3.77)$$

Substituting the components of Eq (3.77) in (3.76) we obtain :

$$\vec{\omega} \times \vec{H} = qr(I_{zz} - I_{xx})\vec{i}_b + pr(I_{xx} - I_{zz})\vec{j}_b + pq(I_{yy} - I_{xx})\vec{k}_b \quad (3.78)$$

Substituting the components of Eqs (3.74) and (3.78) in Eq (3.72). Thus

$$\begin{cases} \sum M_x = \dot{p}I_{xx} + qr(I_{zz} - I_{xx}) \\ \sum M_y = \dot{q}I_{yy} + pr(I_{xx} - I_{zz}) \\ \sum M_z = \dot{r}I_{zz} + pq(I_{yy} - I_{xx}) \end{cases} \quad (3.79)$$

These equations are used to calculate the angular acceleration when the moments on the missile are given. If the moment terms  $L$ ,  $M$ , and  $N$  in Eq (3.73) are separated as :

$$\begin{cases} \sum L = L_A + L_P \\ \sum M = M_A + M_P \\ \sum N = N_A + N_P \end{cases} \quad (3.80)$$

the equations of rotational motion become :

$$\begin{cases} \dot{p} = [(L_A + L_P) + qr(I_{zz} - I_{xx})]/I_{xx} \\ \dot{q} = [(M_A + M_P) + pr(I_{xx} - I_{zz})]/I_{yy} \\ \dot{r} = [(N_A + N_P) + pq(I_{yy} - I_{xx})]/I_{zz} \end{cases} \quad (3.81)$$

where

$\dot{p}$ ,  $\dot{q}$ ,  $\dot{r}$  = components of angular acceleration  $\dot{\omega}$  expressed in body coordinate system (roll, pitch, and yaw, respectively)

$p$ ,  $q$ ,  $r$  = components of angular rate vector  $\omega$  expressed in body coordinate system (roll, pitch, and yaw, respectively)

$L_A$ ,  $M_A$ ,  $N_A$  = components of aerodynamic moment vector expressed in body coordinate system (roll, pitch, and yaw, respectively).

$L_P$ ,  $M_P$ ,  $N_P$  = components of propulsion moment vector expressed in body coordinate system (roll, pitch, and yaw, respectively).

$I_{xx}$ ,  $I_{yy}$ ,  $I_{zz}$  = the moments of inertia (diagonal elements of inertia matrix when products of inertia are zero)

### 3.5.3 Rate of change of Euler angles

The angular orientation of the missile is given by three rotations  $\psi$ ,  $\theta$ , and  $\phi$  relative to the inertial frame of reference. These are called Euler rotations, and the order of the successive rotations is important. Starting with the body coordinate frame  $(x_{b0}, y_{b0}, z_{b0})$  aligned with the earth coordinate frame  $(x_e, y_e, z_e)$ , the generally accepted order is:

1. Rotate the body frame about the  $z_b$ -axis through the heading angle  $\psi$  we obtain  $(x_{b1}, y_{b1}, z_{b1})$ .

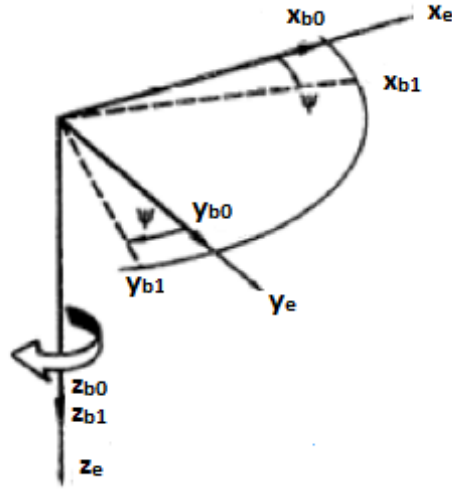

Figure 3.6: First rotation (Heading, Yaw angle  $\psi$ )

$$\begin{pmatrix} x_{b1} \\ y_{b1} \\ z_{b1} \end{pmatrix} = \begin{pmatrix} \cos \psi & \sin \psi & 0 \\ -\sin \psi & \cos \psi & 0 \\ 0 & 0 & 1 \end{pmatrix} \begin{pmatrix} x_{b0} \\ y_{b0} \\ z_{b0} \end{pmatrix} = T_3(\psi) \begin{pmatrix} x_{b0} \\ y_{b0} \\ z_{b0} \end{pmatrix} \quad (3.82)$$

2. Rotate about the  $y_b$ -axis through the pitch angle  $\theta$  we obtain  $(x_{b2}, y_{b2}, z_{b2})$ .

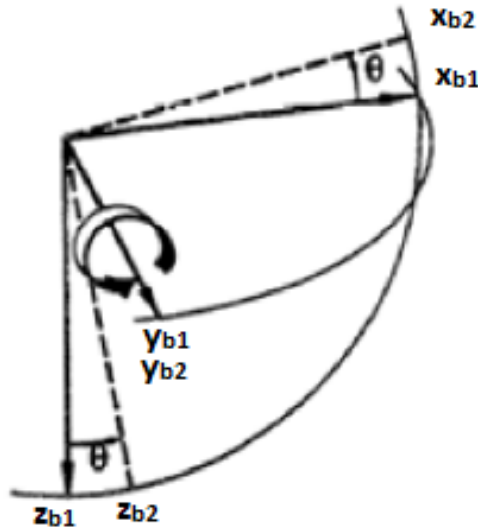

Figure 3.7: Second rotation (pitch angle  $\theta$ )

$$\begin{pmatrix} x_{b2} \\ y_{b2} \\ z_{b2} \end{pmatrix} = \begin{pmatrix} \cos \theta & 0 & -\sin \theta \\ 0 & 1 & 0 \\ \sin \theta & 0 & \cos \theta \end{pmatrix} \begin{pmatrix} x_{b1} \\ y_{b1} \\ z_{b1} \end{pmatrix} = T_2(\theta) \begin{pmatrix} x_{b1} \\ y_{b1} \\ z_{b1} \end{pmatrix} \quad (3.83)$$

3. Rotate about the  $x_b$ -axis through the roll angle  $\phi$  we obtain  $(x_b, y_b, z_b)$  as shown in this figure.

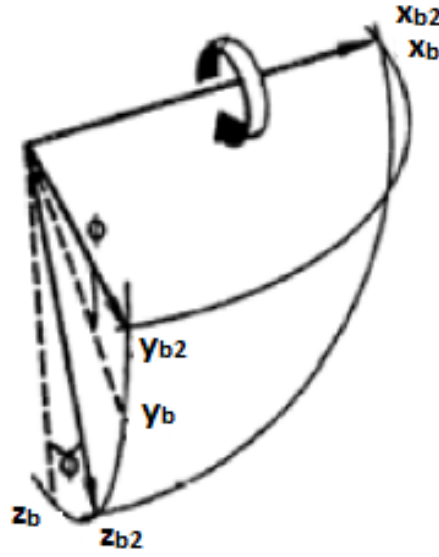

Figure 3.8: Third rotation (Roll angle  $\phi$ )

$$\begin{pmatrix} x_b \\ y_b \\ z_b \end{pmatrix} = \begin{pmatrix} 1 & 0 & 0 \\ 0 & \cos \phi & \sin \phi \\ 0 & -\sin \phi & \cos \phi \end{pmatrix} \begin{pmatrix} x_{b2} \\ y_{b2} \\ z_{b2} \end{pmatrix} = T_1(\phi) \begin{pmatrix} x_{b2} \\ y_{b2} \\ z_{b2} \end{pmatrix} \quad (3.84)$$

$$\begin{pmatrix} x_b \\ y_b \\ z_b \end{pmatrix} = T_3(\psi)T_2(\theta)T_1(\phi) \begin{pmatrix} x_{b0} \\ y_{b0} \\ z_{b0} \end{pmatrix} \quad (3.85)$$

where

$$\mathbf{T}(\phi, \theta, \psi) = T_3(\psi)T_2(\theta)T_1(\phi) \quad (3.86)$$

by taking the inverse of  $\mathbf{T}(\phi, \theta, \psi)$  we get :

$$\begin{pmatrix} x_{b0} \\ y_{b0} \\ z_{b0} \end{pmatrix} = \mathbf{T}^T(\phi, \theta, \psi) \begin{pmatrix} x_b \\ y_b \\ z_b \end{pmatrix} \quad (3.87)$$

**Properties:** The rotation matrix  $\mathbf{T}(\phi, \theta, \psi)$  has the following properties:

1.  $\mathbf{T}\mathbf{T}^T = \mathbf{T}^T\mathbf{T} = \mathbf{I}$
2.  $\det(\mathbf{T}) = 1$
3. Each column (and each row) of  $\mathbf{T}$  is a unit vector.
4. Each columns (and each rows) of  $\mathbf{T}$  are mutually orthogonal.

Because the reference frames are rotating relative to each other, the direction matrix  $\mathbf{T}(\phi, \theta, \psi)$  is function of time ,taking the time derivative of the last equation we get:

$$\frac{d}{dt} \begin{pmatrix} x_{b0} \\ y_{b0} \\ z_{b0} \end{pmatrix} = \begin{pmatrix} 0 \\ 0 \\ 0 \end{pmatrix} = \frac{d}{dt} \mathbf{T}^T(\phi, \theta, \psi) \begin{pmatrix} x_b \\ y_b \\ z_b \end{pmatrix} + \mathbf{T}^T(\phi, \theta, \psi) \frac{d}{dt} \begin{pmatrix} x_b \\ y_b \\ z_b \end{pmatrix} \quad (3.88)$$

we obtain

$$\frac{d}{dt} \mathbf{T}^T(\phi, \theta, \psi) \begin{pmatrix} x_b \\ y_b \\ z_b \end{pmatrix} + \mathbf{T}^T(\phi, \theta, \psi) \begin{pmatrix} \vec{\omega} \times \vec{x}_b \\ \vec{\omega} \times \vec{y}_b \\ \vec{\omega} \times \vec{z}_b \end{pmatrix} = \begin{pmatrix} 0 \\ 0 \\ 0 \end{pmatrix} \quad (3.89)$$

we know that  $\vec{a} \times \vec{b} = \Omega_a \vec{b}$  with

$$[\Omega_a] = \begin{bmatrix} 0 & -a_z & a_y \\ a_z & 0 & -a_x \\ -a_y & a_x & 0 \end{bmatrix} \quad (3.90)$$

so the Eq (3.89) can be written as :

$$\frac{d}{dt} \mathbf{T}^T(\phi, \theta, \psi) \begin{pmatrix} x_b \\ y_b \\ z_b \end{pmatrix} + \mathbf{T}^T(\phi, \theta, \psi) [\Omega_\omega] \begin{pmatrix} x_b \\ y_b \\ z_b \end{pmatrix} = \begin{pmatrix} 0 \\ 0 \\ 0 \end{pmatrix} \quad (3.91)$$

we simplify the last equation by writting:

$$\begin{aligned} \mathbf{T}(\phi, \theta, \psi) &= \mathbf{T} \\ \mathbf{T}^T(\phi, \theta, \psi) &= \mathbf{T}^T \end{aligned}$$

$$\frac{d\mathbf{T}^T}{dt} + \mathbf{T}^T [\Omega_\omega] = 0 \quad (3.92)$$

so

$$[\Omega_\omega] = -\mathbf{T} \left( \frac{d\mathbf{T}^T}{dt} \right) \quad (3.93)$$

we know from the properties of the rotation matrix that  $\mathbf{T}\mathbf{T}^T = I$  so:

$$\left( \frac{d\mathbf{T}}{dt} \right) \mathbf{T}^T + \mathbf{T} \left( \frac{d\mathbf{T}^T}{dt} \right) = 0 \quad (3.94)$$

this implies that:

$$[\Omega_\omega] = \left( \frac{d\mathbf{T}}{dt} \right) \mathbf{T}^T = -\mathbf{T} \left( \frac{d\mathbf{T}^T}{dt} \right) \quad (3.95)$$

where

$$[\Omega_\omega] = \begin{bmatrix} 0 & -\omega_z & \omega_y \\ \omega_z & 0 & -\omega_x \\ -\omega_y & \omega_x & 0 \end{bmatrix} \quad (3.96)$$

by applying the chain rule we get :

$$\frac{d\mathbf{T}}{dt} = \frac{d\mathbf{T}}{d\phi} \frac{d\phi}{dt} + \frac{d\mathbf{T}}{d\theta} \frac{d\theta}{dt} + \frac{d\mathbf{T}}{d\psi} \frac{d\psi}{dt} \quad (3.97)$$



multiplying the Eq (3.97) by  $\mathbf{T}^T$  we get :

$$\left(\frac{d\mathbf{T}}{dt}\right)\mathbf{T}^T = \left(\frac{d\mathbf{T}}{d\phi}\frac{d\phi}{dt} + \frac{d\mathbf{T}}{d\theta}\frac{d\theta}{dt} + \frac{d\mathbf{T}}{d\psi}\frac{d\psi}{dt}\right)\mathbf{T}^T \quad (3.98)$$

$$\left(\frac{d\mathbf{T}}{dt}\right)\mathbf{T}^T = \left(\frac{d\mathbf{T}}{d\phi}\right)\mathbf{T}^T\dot{\phi} + \left(\frac{d\mathbf{T}}{d\theta}\right)\mathbf{T}^T\dot{\theta} + \left(\frac{d\mathbf{T}}{d\psi}\right)\mathbf{T}^T\dot{\psi} \quad (3.99)$$

from the Eq (3.95) and (3.99) we can get the components of the angular velocity  $\vec{\omega}$  in terms of Euler angles  $(\phi, \theta, \psi)$  and its rate of change  $(\dot{\phi}, \dot{\theta}, \dot{\psi})$  expressed in the rotating frame :

$$\begin{aligned} \vec{\omega} &= \dot{\phi}\vec{x}_b + \dot{\theta}\vec{y}_{b2} + \dot{\psi}\vec{z}_{b1} \\ &= (\vec{x}_b \ \vec{y}_b \ \vec{z}_b) \begin{pmatrix} \dot{\phi} \\ 0 \\ 0 \end{pmatrix} + (\vec{x}_{b2} \ \vec{y}_{b2} \ \vec{z}_{b2}) \begin{pmatrix} 0 \\ \dot{\theta} \\ 0 \end{pmatrix} + (\vec{x}_{b1} \ \vec{y}_{b1} \ \vec{z}_{b1}) \begin{pmatrix} 0 \\ 0 \\ \dot{\psi} \end{pmatrix} \\ &= (\vec{x}_b \ \vec{y}_b \ \vec{z}_b) \begin{pmatrix} \dot{\phi} \\ 0 \\ 0 \end{pmatrix} + (\vec{x}_b \ \vec{y}_b \ \vec{z}_b) T_1(\phi) \begin{pmatrix} 0 \\ \dot{\theta} \\ 0 \end{pmatrix} + (\vec{x}_b \ \vec{y}_b \ \vec{z}_b) T_1(\phi) T_2(\theta) \begin{pmatrix} 0 \\ 0 \\ \dot{\psi} \end{pmatrix} \end{aligned} \quad (3.100)$$

$$\vec{\omega} = (\vec{x}_b \ \vec{y}_b \ \vec{z}_b) \left[ \begin{pmatrix} \dot{\phi} \\ 0 \\ 0 \end{pmatrix} + T_1(\phi) \begin{pmatrix} 0 \\ \dot{\theta} \\ 0 \end{pmatrix} + T_1(\phi) T_2(\theta) \begin{pmatrix} 0 \\ 0 \\ \dot{\psi} \end{pmatrix} \right] \quad (3.101)$$

$$\begin{pmatrix} p \\ q \\ r \end{pmatrix} = \begin{bmatrix} 1 & 0 & -\sin\theta \\ 0 & \cos\phi & \cos\theta \sin\phi \\ 0 & -\sin\phi & \cos\theta \cos\phi \end{bmatrix} \begin{pmatrix} \dot{\phi} \\ \dot{\theta} \\ \dot{\psi} \end{pmatrix} \quad (3.102)$$

By taking the inverse of the transformation matrix in the last equation we get the relationship which represents the rate of change of the Euler angles in terms of the components of the angular velocity  $\omega$  in the body reference frame  $(p, q, r)$

$$\begin{cases} \dot{\phi} = p + (q \sin\phi + r \cos\phi) \tan\theta \\ \dot{\theta} = q \cos\phi - r \sin\phi \\ \dot{\psi} = (q \sin\phi + r \cos\phi) / \cos\theta \end{cases} \quad (3.103)$$

where

$\phi, \theta, \psi$  = the euler angles rotations in roll, pitch and yaw respectively.

$\dot{\phi}, \dot{\theta}, \dot{\psi}$  = the rate of change of euler angles rotations in roll, pitch and yaw respectively.

$p, q, r$  = the components of the angular velocity  $\omega$  expressed in the body reference frame.

The missile final model is given by these nine differential equations:

$$\left\{ \begin{array}{l} \dot{u} = \frac{(F_{Ax} + F_{Px} + F_{gx})}{m} - (qw - rv) \\ \dot{v} = \frac{(F_{Ay} + F_{Py} + F_{gy})}{m} - (ru - pw) \\ \dot{w} = \frac{(F_{Az} + F_{Pz} + F_{gz})}{m} - (pv - qu) \\ \dot{p} = [(L_A + L_P) + qr(I_{zz} - I_{xx})]/I_{xx} \\ \dot{q} = [(M_A + M_P) + pr(I_{xx} - I_{zz})]/I_{yy} \\ \dot{r} = [(N_A + N_P) + pq(I_{yy} - I_{xx})]/I_{zz} \\ \dot{\phi} = p + (q \sin \phi + r \cos \phi) \tan \theta \\ \dot{\theta} = q \cos \phi - r \sin \phi \\ \dot{\psi} = (q \sin \phi + r \cos \phi) / \cos \theta \end{array} \right.$$

# Chapter 4

## Aerodynamics of a missile

---

### 4.1 Introduction

In the case of a missile in flight, its behaviour is directly influenced by initial and exterior conditions, such as temperature, pressure, presence of wind, as well as the physical properties of the body (in terms of mass, center of gravity and inertia). All these conditions have an effect on the aerodynamic coefficients. The importance of estimating them lies in the representation of aerodynamic characteristics of a missile, which can be determined by **the wind tunnel measurements, analytical predictions**, or by **flight test**.

### 4.2 Aerodynamic properties

Aerodynamic coefficients are the parameters describing and connecting forces and moments acting on the missile to angles ( $\alpha$ ,  $\beta$ ) and velocities ( $V$  and  $W$ ). Generally, they depend of the flight condition variables such as the velocity, incidence angles, angular rates or accelerations. In that respect, the global coefficients for missile in flight can be characterized as a function of nondimensional quantities as follows

$$C_i(\alpha, \beta, Mn, \dots) \quad (4.1)$$

In practice this nondimensional parameters are inputs for aerodynamic forces and moments which can be given by the familiar form of the aerodynamic force equation employed extensively in aerodynamics:

$$F = 0.5\rho V^2 C_F S. \quad (4.2)$$

Where

$C_F$  = general aerodynamic force coefficient

$F$  = general force (aerodynamic)

$S$  = aerodynamic reference area

$V$  = speed of a body, speed of air relative to a body

$\rho$  = atmospheric density

This last equation is function of an important quantity known as **the dynamic pressure parameter**.

$$F = QC_F S \quad (4.3)$$

- **Dynamic pressure parameter** : The dynamic pressure parameter is equal to the kinetic energy per unit volume of air. There is two equivalent forms of the dynamic pressure parameter

$$Q = 0.5\rho V^2 \quad (4.4)$$

$$Q = 0.7P_a M_n^2 \quad (4.5)$$

Where

$M_n$  = Mach number.

$P_a$  = ambient atmospheric pressure.

$Q$  = dynamic pressure parameter.

Whenever a fluid passes around an object there is a point at which the flow divides, part goes one way and part the other. This point of division is called the stagnation point because, theoretically, the molecules of fluid at this point are brought to rest relative to the object . At the stagnation point the rise in pressure, caused by the loss of all kinetic energy of the fluid is called the dynamic pressure, which in incompressible flow is equal to the dynamic pressure parameter  $Q$ .

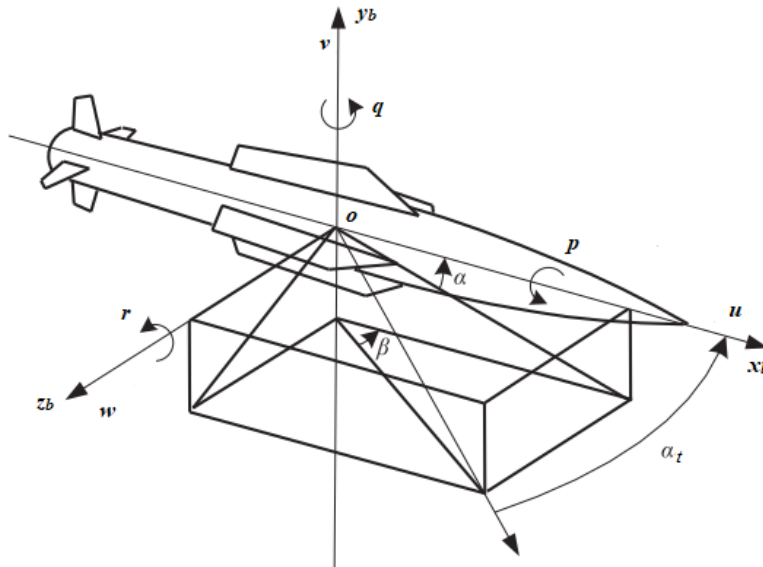

Figure 4.1: Aerodynamic characteristics of missile

Throughout the flight, two angles are defined to describe the aerodynamic effects acting on the missile: the angle of attack ( $\alpha$ ) and the side-slip angle ( $\beta$ ). The lift and drag components of the aerodynamic forces are oriented by  $\alpha$  and  $\beta$ , where these two angles can be obtained by

$$\alpha = \tan^{-1}\left(\frac{w}{u}\right) \quad (4.6)$$

$$\beta = \tan^{-1}\left(\frac{v}{u}\right) \quad (4.7)$$

The total angle of attack can be obtained by substituting these two last equations (4.6) and (4.7) in the following equation, we get :

$$\alpha_t = \cos^{-1}(\cos \alpha \cos \beta) \quad (4.8)$$

Where

$\alpha$  = angle of attack.

$\beta$  = side-slip angle.

$u, v, w$  = components of the linear velocity vector of the missile

### 4.2.1 Force coefficients

The value of the aerodynamic force coefficients for a given body configuration is affected primarily by the shape of the body (including any control-surface deflections), the orientation of the body within the flow (angle of attack), and the flow conditions. The flow conditions can be specified by two parameters: **the Mach number** and **the Reynolds number**.

- **Effect of Mach Number:**

The Mach number is the ratio of the missile speed, i.e., the relative speed of fluid flow, to the speed of sound in the ambient air.

$$Mn = \frac{V_M}{V_s} \quad (4.9)$$

$V_s$  is calculated using the following formula:

$$V_s = \sqrt{\gamma RT} \quad (4.10)$$

where

$V_s$  = speed of sound at altitude  $h$

$R$  = gas constant (287.05)

$T$  = temperature at an altitude

$\gamma$  = ratio of specific heat (1.4)

As the missile speed approaches and exceeds the speed of sound, the compressibility characteristics of the air have a pronounced effect on the aerodynamic forces and moments. The aerodynamic coefficients in turn depend on these characteristics of the flow. The different flow characteristics are grouped into five basic flow regimes based on Mach number  $Mn$ , these regimes are described as :

1. Incompressible subsonic flow:  $0 < Mn < 0.3,$
2. Compressible subsonic flow:  $0.5 \leq Mn < 0.8,$
3. Transonic flow:  $0.8 \leq Mn < 1.2,$
4. supersonic flow:  $1.2 \leq Mn < 5,$
5. Hypersonic flow:  $5 \leq Mn.$

- **Effect of Reynolds Number :**

The Reynolds number is a measure of the ratio of the inertial properties of the fluid flow to the viscous properties. Reynolds number is given by :

$$Re = \frac{\rho V d}{\mu} \quad (4.11)$$

Where:

$Re$  = Reynolds Number.

$d$  = aerodynamic reference length of body.

$V$  = speed of a body, speed of air relative to a body, magnitude of velocity vector.

$\mu$  = atmospheric dynamic viscosity.

$\rho$  = atmospheric density.

The reference length  $d$  is a scale factor that accounts for the effect of the size of the missile on the flow characteristics. The missile diameter is often selected as the reference length, but the length of the missile body is also commonly used. Force coefficients are functions of Reynolds number. When a force coefficient is given, the Reynolds number upon which it is based must also be given; in addition, the missile dimension used as a reference length for the Reynolds number must be specified.

### 4.2.2 Components of force coefficients

The decomposition of the force coefficients depends on the context and on the chosen reference frame.

#### 4.2.2.1 Drag coefficient $C_D$

The drag coefficient  $C_D$  corresponds to the aerodynamic resistance and is related to the force which is opposed to the body motion in a fluid. Mathematically, it is the component along the tangent to the trajectory in the opposite direction of the relative body velocity

$$D = 0.5\rho V^2 C_D S \quad (4.12)$$

or

$$C_D = C_{D_0} + kC_L^2 \quad (4.13)$$

Where

$D$  = magnitude of aerodynamic drag force vector

$S$  = aerodynamic reference area

$V$  = speed of body, speed of air relative to body, magnitude of velocity vector

$\rho$  = atmospheric density

$C_D$  = aerodynamic drag coefficient

$C_{D_0}$  = zero-lift drag coefficient

$k$  = constant depending on body shape and flow regime

$C_L$  = aerodynamic lift coefficient

#### 4.2.2.2 Lift coefficient $C_L$

The Lift coefficient  $C_L$  is representative of the force perpendicular to the trajectory induced by the pressure distribution around the missile when the angle of attack  $\alpha$  is different of zero. In that respect, it is more common to quantify the lift force coefficient slope  $C_{L_\alpha}$  representing the derivative of the lift force coefficient

$$L = 0.5\rho V^2 C_L S \quad (4.14)$$

or

$$C_L = C_{L_\alpha} \alpha \quad (4.15)$$

Where

$L$  = magnitude of aerodynamic lift force vector

$S$  = aerodynamic reference area

$V$  = speed of body, speed of air relative to body, magnitude of velocity vector

$\rho$  = atmospheric density

$C_L$  = aerodynamic lift coefficient

$C_{L_\alpha}$  = slope of curve formed by lift coefficient  $C_L$  versus angle of attack  $\alpha$

$\alpha$  = angle of attack

### 4.2.3 Components of moment coefficients

The moments exerted by aerodynamic forces on a missile are calculated by the moment coefficients  $C_l$ ,  $C_m$ , and  $C_n$  for roll, pitch, and yaw, respectively. This moment usually is approximated by the

normal force acting at the center of pressure with a lever arm equal to the distance between the center of mass and the center of pressure.

- **Rolling moment:** Is the torque about the missile longitudinal axis ( $x_b$ -axis) that is created by a differential lift, generated by surfaces deflections and can be modeled by linear function as:

$$L_A = 0.5\rho V^2 C_l S d \quad (4.16)$$

- **Pitching moment:** Is the moment about the missile lateral axis ( $y_b$ -axis) that is generated the result of the lift and the drag forces acting on the missile, which can be modeled by a linear function as:

$$M_A = 0.5\rho V^2 C_m S d \quad (4.17)$$

- **Yawing moment:** Is the torque about the vertical axis of the missile ( $z_b$ -axis), and can be modeled as:

$$N_A = 0.5\rho V^2 C_n S d \quad (4.18)$$

Where

$L_A, M_A, N_A$  = components of aerodynamic moment vector  $M$  expressed in body coordinate system (roll, pitch, and yaw, respectively).

$S$  = aerodynamic reference area.

$V$  = speed of body, speed of air relative to body.

$\rho$  = atmospheric density.

$C_l$  = aerodynamic roll moment coefficient about center of mass.

$C_m$  = aerodynamic pitch moment coefficient about center of mass.

$C_n$  = aerodynamic yaw moment coefficient about center of mass.

The missile aerodynamic moments  $M$  given in Eqs (4.10) , (4.11) and (4.12) can be represented as the sum of the aerodynamic relative to the body ( $B$ ), the fins ( $F$ ) and the damping effect ( $D$ ), as follows :

$$M = M_B + M_F + M_D$$

And as the distance between the center of mass and the center of pressure changes before motor burnout because of the mass redistribution that occurs when propellant burns and expelled Therefore, it is necessary to correct the moment coefficient.

This implies that the global moment coefficients, more precisely the roll, pitch and yaw moment coefficients  $C_l, C_m$  and  $C_n$  can be written as:

$$\begin{bmatrix} C_l \\ C_m \\ C_n \end{bmatrix} = \begin{bmatrix} 0 \\ C_{m_\alpha} \alpha - C_{N_z} \left( \frac{x_{cm} - x_{ref}}{d} \right) \\ C_{n_\beta} \beta + C_{N_y} \left( \frac{x_{cm} - x_{ref}}{d} \right) \end{bmatrix} + \begin{bmatrix} C_{l_\delta} \delta_r \\ C_{m_\delta} \delta_p \\ C_{n_\delta} \delta_y \end{bmatrix} + \frac{d}{2V} \begin{bmatrix} C_{l_p} p \\ (C_{m_q} + C_{m_{\dot{\alpha}}}) q \\ (C_{n_r} + C_{n_{\dot{\beta}}}) r \end{bmatrix} \quad (4.19)$$

By taking

$$\begin{cases} C_{m_{ref}} = C_{m_\alpha} \alpha + C_{m_\delta} \delta_p \\ C_{n_{ref}} = C_{n_\beta} \beta + C_{n_\delta} \delta_y \end{cases} \quad (4.20)$$

Where

$C_{n_\beta}$  = slope of curve formed by yawing moment coefficient  $C_n$  versus angle of sideslip

$C_{n_\delta}$  = slope of curve i.e yawing moment coefficient  $C_n$  versus control-surface deflection  $\delta_y$

$C_{m_\alpha}$  = slope of curve formed by pitch moment coefficient  $C_m$  versus angle of attack  $\alpha$

$C_{n_\alpha}$  = slope of curve i.e. pitch moment coefficient  $C_m$  versus control-surface deflection  $\delta_p$   
 $\delta_p$  = angle of effective control-surface deflection in the pitch direction  
 $\delta_r$  = effective control-surface deflection angle corresponding to roll  
 $\delta_y$  = angle of effective control-surface deflection in the yaw direction

Since the missile is assumed to have cruciform symmetry, therefore

$$C_{m_\alpha} = C_{n_\beta} \quad , \quad C_{m_q} = C_{n_r} \quad , \quad C_{m_\delta} = C_{n_\delta} \quad , \quad C_{m_{\dot{\alpha}}} = C_{n_{\dot{\beta}}}$$

So the equation of moments coefficients can be expressed as

$$C_l = C_{l_\delta} \delta_r + \frac{d}{2V} C_{l_p} p \quad (4.21)$$

$$C_m = C_{m_{ref}} - C_{N_z} \left( \frac{x_{cm} - x_{ref}}{d} \right) + \frac{d}{2V} (C_{m_q} + C_{m_{\dot{\alpha}}}) q \quad (4.22)$$

$$C_n = C_{n_{ref}} + C_{N_y} \left( \frac{x_{cm} - x_{ref}}{d} \right) + \frac{d}{2V} (C_{n_r} + C_{n_{\dot{\beta}}}) r \quad (4.23)$$

Where

$C_m$  = aerodynamic pitch moment coefficient about center of mass

$C_n$  = aerodynamic yaw moment coefficient about center of mass

$V$  = speed of body, speed of air relative to body

$C_{m_{ref}}$  = pitching moment coefficient about reference moment station

$C_{n_{ref}}$  = yawing moment coefficient about reference moment station

$d$  = aerodynamic reference length of body

$p, q, r$  = missile (roll, pitch, yaw) rates, expressed in body coordinate system

$\alpha$  = angle of attack in pitch plane

$\beta$  = sideslip angle

$C_{N_y}$  = coefficient corresponding to component of normal force on  $y_b$  axis

$C_{N_z}$  = coefficient corresponding to component of normal force on  $z_b$  axis

$C_{n_r}$  = yaw damping derivative relative to yaw rate

$C_{n_{\dot{\beta}}}$  = yaw damping derivative relative to angle-of sideslip rate

$C_{m_q}$  = pitch damping derivative relative to pitch rate

$C_{m_{\dot{\alpha}}}$  = pitch damping derivative relative to angle of attack rate

$x_{cm}$  = instantaneous distance from missile nose to center of mass

$x_{ref}$  = distance from missile nose to reference moment station

The coefficients corresponding to the components of the normal force in the  $y_b$  and  $z_b$  axes are calculated by

$$C_{N_y} = \frac{F_{A_{y_b}}}{QS} \quad (4.24)$$

$$C_{N_z} = \frac{F_{A_{z_b}}}{QS} \quad (4.25)$$

Where

$C_{N_y}$  = coefficient corresponding to component of normal force on  $y_b$  axis.

$C_{N_z}$  = coefficient corresponding to component of normal force on  $z_b$  axis.

$Q$  = dynamic pressure parameter.

$S$  = aerodynamic reference area.



## 4.3 Atmospheric properties

The aerodynamic forces depend on certain properties of the atmosphere such as temperature, pressure, density and viscosity of the air, this last is important in aerodynamics because air tends to stick to any surface over which it flows, slowing down the motion of the air. This properties changes with altitude, that in turn produce variation in the aerodynamic forces and moments coefficients.

Equations used to extrapolate atmospheric properties are often based on the following simplifying assumptions:

1. The air is dry.
2. The air behaves as a perfect gas.
3. The gravity field is constant.
4. The rate of change of temperature with altitude (lapse rate) is constant within a specified altitude region.

- **Tempertaure**

$$T = T_1 + a(h - h_1) \quad (4.26)$$

where

$T$  = temperature at altitude  $h$ .

$T_1$  = given temperature at altitude  $h_1$ .

$h$  = altitude for which atmospheric properties are to be calculated above sea level.

$h_1$  = reference altitude at sea level (or earth surface).

$a$  = lapse rate(0.0065 K/m).

- **Pressure**

$$P = P_1 + \left( \frac{T}{T_1} \right)^{-\frac{g_0}{aR}} \quad (4.27)$$

Where

$P$  = pressure at altitude  $h$ .

$P_1$  = pressure at given altitude  $h_1$ .

$R$  = gas constant (287.05).

$g_0$  = magnitude of the acceleration vector  $\vec{g}_0$  due to gravity at the earth surface.

$a$  = lapse rate(0.0065 K/m).

- **Atmospheric density**

$$\rho = \frac{P}{RT} \quad (4.28)$$

Where

$\rho$  = atmospheric density.

$P$  = pressure at altitude  $h$ .

$R$  = gas constant (287.05).

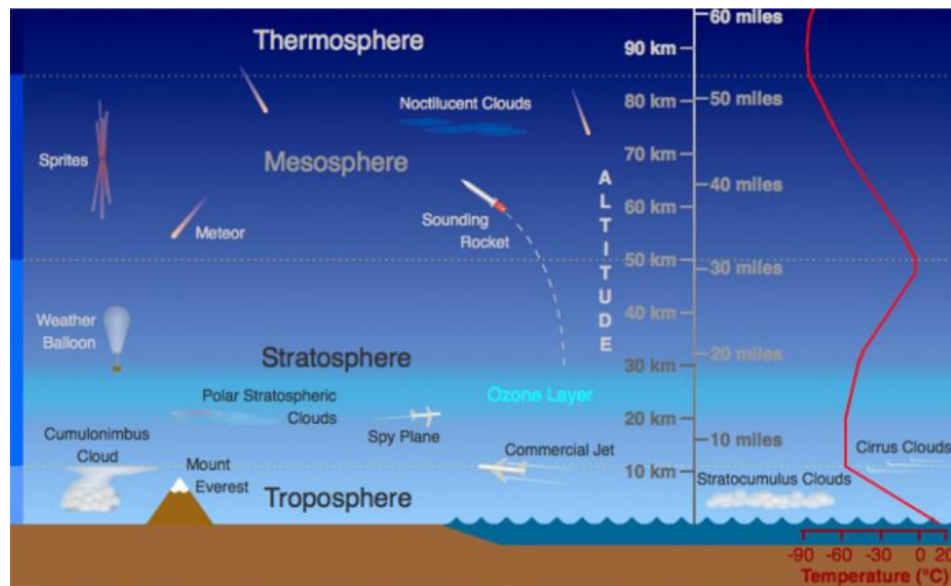

Figure 4.2: Atmosphere characteristics.

# Chapter 5

## Guidance and control system

This chapter presents a discussion and overview of missile guidance and control system as well as the basic equations that are used in intercepting a given target.

### 5.1 Introduction

The purpose of missile guidance and control is to make the missile hit the target at the end of its flight. In order to achieve this goal, it is essential for the missile to constantly acquire the motion information of the target and of the missile itself in the course of the flight and adopt a tactic (that is a guidance law) to decide how to change the missile's velocity direction based on the current missile and target relative motion, allowing the missile to finally hit the target [7].

Figure 5.1 illustrates the missile guidance and control loop.

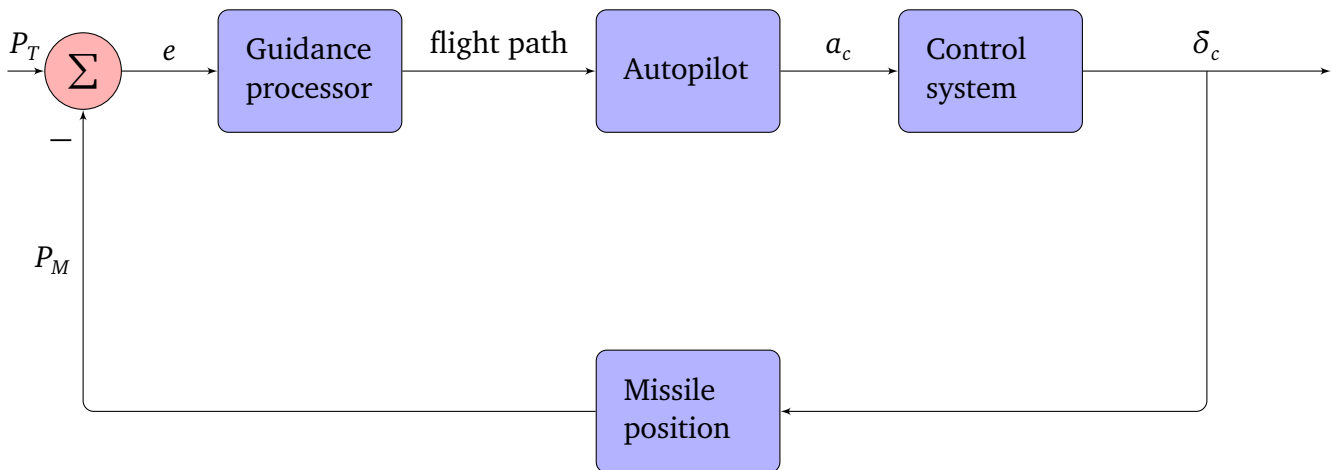

Figure 5.1: Guidance loop

## 5.2 Guidance intercept techniques

Two basic guidance concepts will be discussed: (a) **the homing guidance system**, which guides the interceptor missile to the target by means of a target seeker and an onboard computer; homing guidance can be modeled as *active*, *semiactive*, and *passive*; and (b) **command guidance**, which relies on missile guidance commands calculated at the ground launching (controlling) site and transmitted to the missile. In addition to these guidance systems, two other forms of missile guidance have been used in the past or are being used presently: (a) **inertial guidance** and (b) **position-fixing guidance**. Some guided missiles may contain combinations of the above systems [1].

### 5.2.1 Homing guidance or onboard guidance

The expression "**homing guidance**" is used to describe a missile system that can sense the target by some means, and then guide itself to the target by sending commands to its own control surfaces.

Homing is useful in tactical missiles where considerations such as autonomous (or fire-and-forget) operation usually require sensing of target motion to be done from the interceptor missile (or pursuer) itself. Consequently, in such cases the sensor limitations generally restrict the sensed target motion parameters to the set consisting of the direction of the line of sight and its rates of various orders.

#### 5.2.1.1 Active homing

In an active homing system, the target is illuminated and tracked by equipment on board the missile itself. That is, the missile carries the source of radiation on board in addition to the radiation sensor. An active system has the potential to measure relative bearing and range from the missile to the target angular rate of the line of sight to the target, and range rate for use in determining guidance commands.

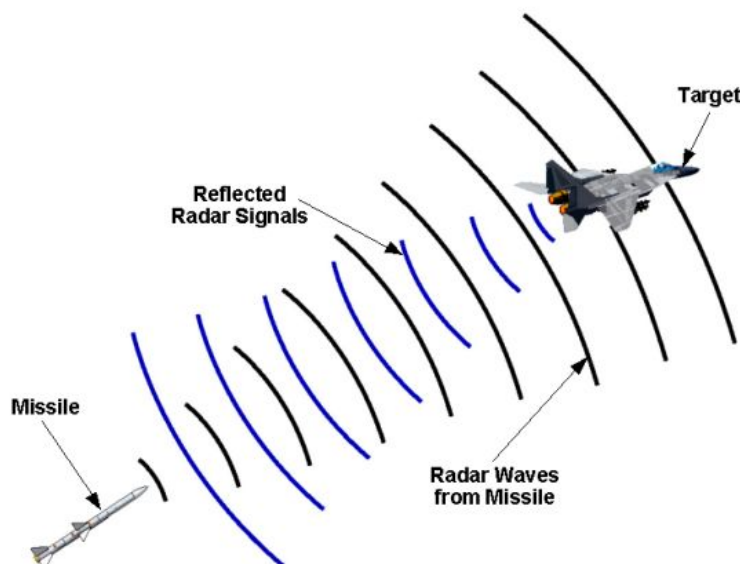

Figure 5.2: Active homing

#### 5.2.1.2 Semiactive homing

A semiactive homing system is one that selects and chases a target by following the energy from an external source, such as a tracking radar, reflecting from the target (Figure 5.3). This illuminating

radar may be ground-based, ship-borne, or airborne. Semiactive homing requires the target to be continuously illuminated by the external radar at all times during the flight of the missile. The illuminating energy may be supplied by the target-tracking radar itself or by a separate transmitter collimated with it.

The radar energy reflected by the target is picked up by a tracking receiver (the seeker) in the nose of the missile and is used by the missile's guidance system. Equipment used in the semiactive homing systems is more complex and bulky than that used in passive systems. It provides homing guidance over much greater ranges and with fewer external limitations in its application.

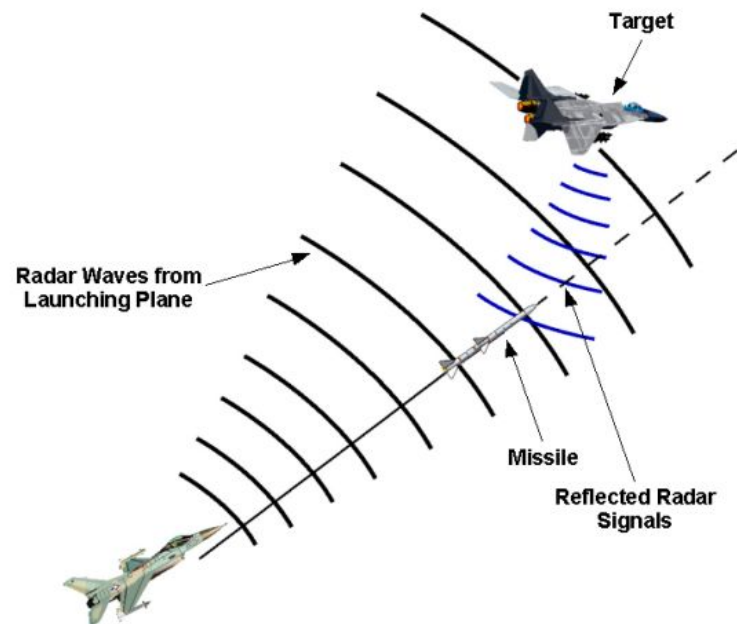

Figure 5.3: Semiactive homing

### 5.2.1.3 Passive homing

A passive guidance system transmits no-power. The power tracked by the onboard seeker is either generated by the target itself (RF or IR), is reflected power generated by a natural source (solar), or is background power blocked by the target (UV). Thus, passive homing guidance systems are based on the use of the characteristic radiation from the target itself as a means of attracting the missile, for example, as in infrared homing systems. In other words, the target acts as a lure. Once a passive seeker is locked onto the target and launched, there is no more need for support from the ground-based launch system. This gives rise to the concept of “fire and forget”, which permits the ground-based system to turn its attention to new targets and new launches. Passive seekers have the potential to measure relative bearing and the angular rate of the line of sight; they cannot, however, measure range or range rate.

## 5.2.2 Ground based guidance

Long-range missiles may require very large target-tracking sensors, too large to be carried onboard the missiles. Also very sophisticated high-speed computations involved in guidance processing and countermeasures rejection have in the past required computation equipment that is too bulky and heavy to be carried onboard the missiles. For these reasons missile systems have been developed with sensors and computers located on the ground. Another reason for ground-based sensors and computation, even for short-range missiles with relatively simple guidance processors, is simply to keep the expendable flight hardware as simple and low in cost as possible.

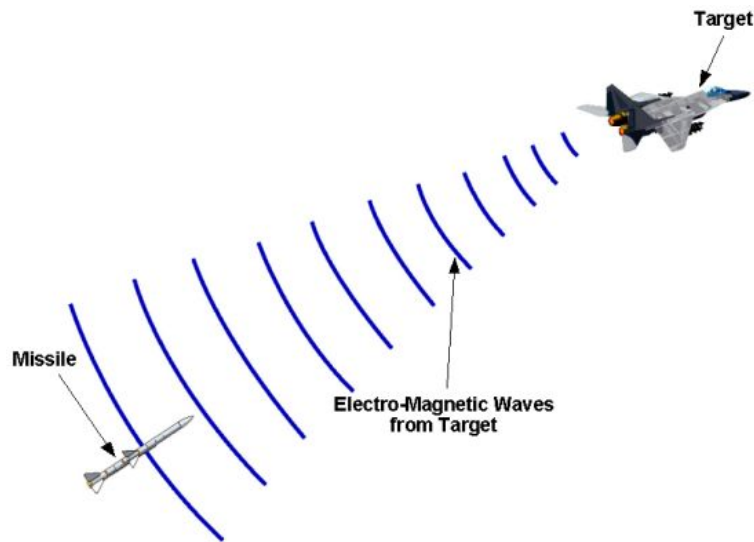

Figure 5.4: Passive homing

### 5.2.2.1 Command guidance

Command guidance receives its name from the fact that guidance commands are generated by a guidance processor that is not a part of the missile. Command guided missiles are missiles whose guidance instructions or commands come from sources outside the missile. In this type of guidance, a tracking system that is separated from the missile is used to track both the missile and the target. Therefore, a missile seeker is not required in command guidance. The tracking system may consist of two separate tracking units, one for the missile and one for the target aircraft, or it may consist of one tracking unit that tracks both vehicles. The tracking can be accomplished using radar, optical, laser, or infrared systems. A radar beacon or infrared flare on the tail of the missile can be used to provide information to the tracking system on the location of the missile. Measured position data for the target and missile are fed into a computer located on the ground. The computer calculates the guidance commands, and they are transmitted to the missile where they are carried out by the autopilot and control system of the missile.

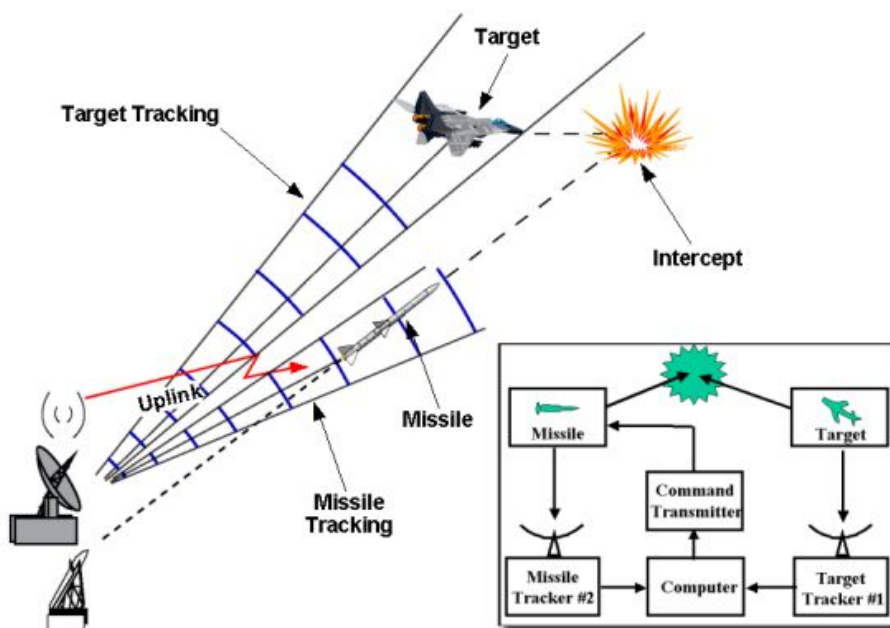

Figure 5.5: Command guidance

### 5.2.2.2 Beam Rider

Beam riding is another form of command guidance. Specifically, in this type of guidance, the aircraft (target) is tracked by means of an electromagnetic beam, which may be transmitted by a ground (or ship or airborne) radar or a laser tracking system (e.g., a ladar (laser detection and ranging), or laser radar). In order to follow or ride the beam, the interceptor missile's onboard guidance equipment includes a rearward-facing antenna, which senses the target-tracking beam. By utilizing the modulation properties of the beam, steering signals that are a function of the position of the missile with respect to the center (or the scanning axis) of the target-tracking beam are computed on board and sent to the control surfaces.

These correction signals produce control surface movements intended to keep the missile as nearly as possible in the center of the target-tracking beam (or scanning axis). For this reason, the interceptor missile is said to ride the beam. Either the beam that the missile rides can track the target directly, or a computer can be used to predict the direction the missile beam should be pointing in order to effect an eventual collision of the interceptor missile with the target. In this case, a separate tracker is required to track the target.

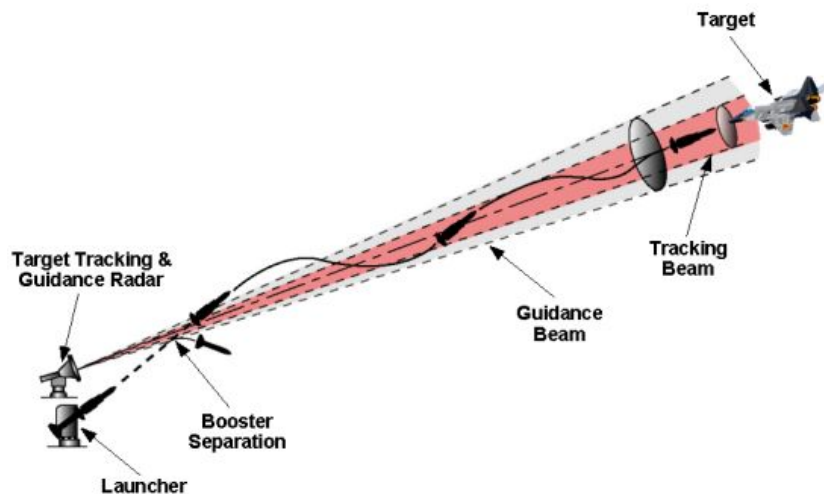

Figure 5.6: Beam rider guidance

### 5.2.2.3 Retransmission Guidance or TVM guidance

This technique is largely similar to command guidance but with a unique twist. The target is tracked via an external radar, but the reflected signal is intercepted by a receiver onboard the missile, as in semi-active homing. However, the missile has no onboard computer to process these signals. The signals are instead transmitted back to the launch platform for processing. The subsequent commands are then retransmitted back to the missile so that it can deflect control surfaces to adjust its trajectory.

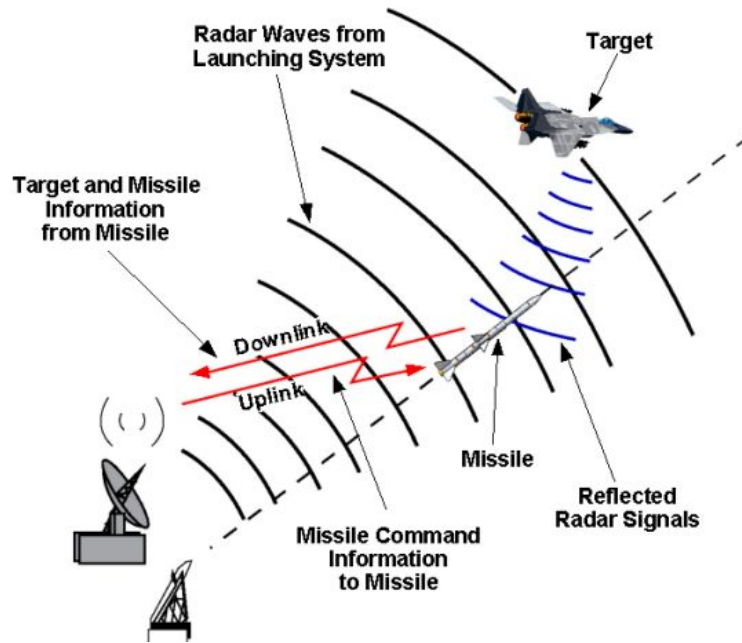

Figure 5.7: TVM guidance

This method is also sometimes called "track via missile" (TVM) since the missile acts as a conduit of tracking information from the target back to the ground control station. The advantage of TVM homing is that most of the expensive tracking and processing hardware is located on the ground where it can be reused for future missile launches rather than be destroyed. Unfortunately, the method also requires excellent high-speed communication links between the missile and control station, limiting the system to rather short ranges. Retransmission guidance is used on the Patriot surface-to-air missile.

### 5.3 Missile autopilot

The autopilot is a link between the function that indicates a change of heading is needed (guidance processor) and the mechanism that can change the heading (control system) as illustrated in the diagram below (5.8).

The " **autopilot** " receives guidance commands and processes them to the controls such as deflections or rates of deflection of control surfaces or jet controls. The control subsystem transfers the autopilot commands to aerodynamic or jet control forces and moments to change the position of the airframe, to attain the commanded maneuver by rotating the body of a missile to a desired angle of attack.

The autopilot response should be attended quickly with minimum overshoot. Minimal overshoot enables a missile to avoid exceeding structural limitations.

The design of the autopilot depends on the aerodynamics of the missile airframe and the type of controls employed. Since some guided missiles must perform over extreme ranges of flight conditions, the autopilot may be designed to compensate for some of the nonlinearities in the aerodynamics in order to ensure a stable system. If the missile design requires roll control, the autopilot may sense roll position or roll rate and issue appropriate control commands. Some missiles require control to compensate for the acceleration due to gravity; in this case the autopilot receives the necessary sensor data and determines the direction and magnitude of the commands required to compensate for gravity.



The autopilot may introduce airframe damping to prevent large overshoots in response to maneuver commands or to compensate for dynamic instabilities. It may contain amplifiers, integrators, and mixing circuits that send signals to the proper control surface actuators. In some applications missile maneuver commands may be produced solely on the basis of the seeker output.



Figure 5.8: Autopilot function

### 5.3.1 Autopilot Modeling

As discussed in the introduction above, an autopilot in a missile has two basic functions to ensure stable flight and to translate the guidance law into control-surface deflection commands.

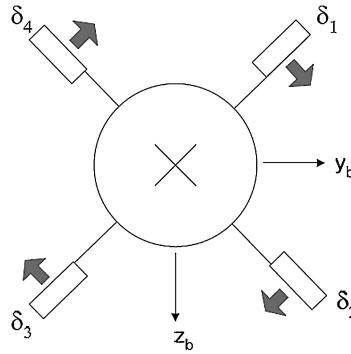

Figure 5.9: Control surfaces

The autopilot model may scale and limit the guidance commands for the structural integrity and stability of the missile and provide feedback loops to ensure that the commands are being accurately executed, depending on the design of the missile and on the objectives of it.

It is assumed in our simulation case that the missile has four control surfaces in a cruciform pattern and that commanded control-surface deflections are proportional to commanded lateral accelerations for maneuver commands and proportional to commanded roll rates for roll commands.

#### 5.3.1.1 Six degree of freedom model

In Six degree of freedom model, the pitch and yaw channels can be considered as decoupled single-input single-output systems; this simplifies their design. A constant roll position creates normal working conditions for missile components.

The relationship between the actuator commands  $\delta_p$ ,  $\delta_Y$ ,  $\delta_R$  and the individual fin deflections is given for this model as follow

$$\delta_p = \frac{\delta_2 - \delta_4}{2}, \quad (5.1a)$$

$$\delta_Y = \frac{\delta_1 - \delta_3}{2}, \quad (5.1b)$$

$$\delta_R = \frac{\delta_1 + \delta_2 + \delta_3 + \delta_4}{4}. \quad (5.1c)$$

where

$\delta_p$  = autopilot pitch fin command,

$\delta_Y$  = autopilot yaw fin command,

$\delta_R$  = autopilot roll fin commands.

$\delta_i$  = deflection angle of  $i^{th}$  control surface,  $i = 1,2,3,4$ .

The restrictions related to the fin deflections are transformed into the autopilot limits ( $\delta_p$ ,  $\delta_Y$ ,  $\delta_R$ ), which, in turn, impose constraints on the missile acceleration [5].

### 5.3.1.2 Five degree of freedom model

In Five degree of freedom model, the pitch and yaw channels are coupled and roll rate is set to zero, thus the actuator commands are

$$\delta_p = \frac{\delta_2 - \delta_4}{2}, \quad (5.2a)$$

$$\delta_Y = \frac{\delta_1 - \delta_3}{2}, \quad (5.2b)$$

$$\delta_R = 0. \quad (5.2c)$$

where

$$\delta_1 = -\delta_3,$$

$$\delta_2 = -\delta_4.$$

The negative sign is a consequence of the difference in orientation direction see ( figure 5.9 ).

## 5.4 Missile control system

Once the guidance processor has determined the magnitude and direction of the error in the missile flight path and the autopilot has determined the steering command, the missile control system must adjust the control surfaces to produce the acceleration required to correct the flight path. This corrective acceleration is applied in a lateral direction (perpendicular to the missile flight path) to change the direction of the missile velocity vector. A moment, i.e., a force multiplied by a lever arm, is required to cause a missile to rotate to achieve an angle of attack. This moment can be developed by several means such as thrust vector control and aerodynamic fin deflection.

### 5.4.1 Fin deflection control

In aerodynamic fin deflection the airflow over the deflected control surfaces produces an aerodynamic moment on the missile that causes the missile to rotate relative to its velocity vector and thus achieve an angle of attack. Commonly, aerodynamically guided missiles have two axes of symmetry, that is, arranged in a cruciform configuration as shown in Figure (5.9).

#### 5.4.1.1 Canard control

The lift in canard control configuration is developed on the fin itself. This lift, acting on the lever arm relative to the missile center of mass, produces a nose-up moment when the fin is deflected as shown in figure 5.10. The magnitude of the aerodynamic moment is proportional to the lift  $L$  that acts on the control surface. The lift in turn is dependent on the deflection angle of the control surface.

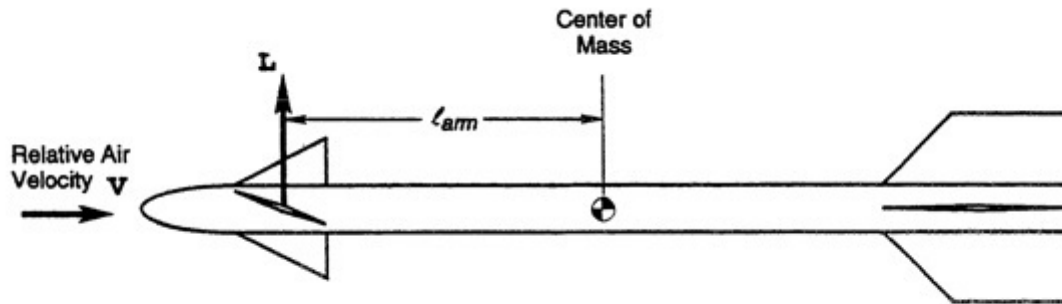

Figure 5.10: Aerodynamic moment in canard control

#### 5.4.1.2 Tail control

Figure 5.11 shows the use of tail surfaces for control. With tail control the lift on the control surface is in the direction opposite to the desired lateral acceleration of the missile so that the lift on the control surface subtracts from the overall missile lift.

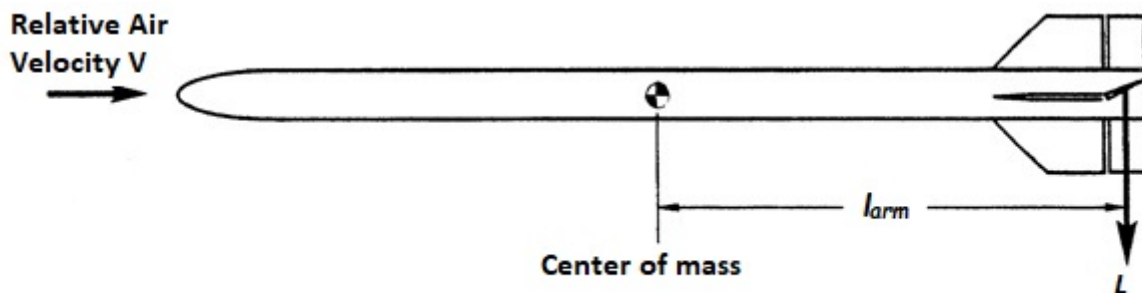

Figure 5.11: Aerodynamic moment in tail control

### 5.4.2 Thrust vector control

In thrust vector control, steering of the missile is accomplished by altering the direction of the efflux from the propulsion motor. In this design, a thrust vector controller is used to follow the thrust vector command see figure 5.12.

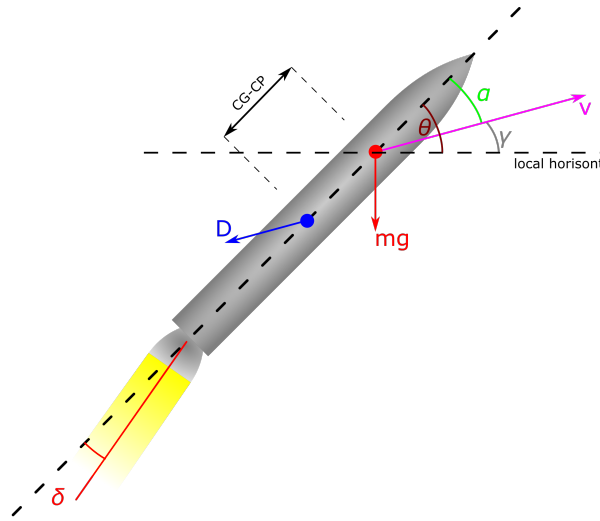

Figure 5.12: Aerodynamic moment in canard control

More specifically, the fire control system can command the thrust generator to generate the thrust amplitude and direction commands. Consequently, the thrust amplitude obtained by controlling the exhaust mass flow rate and the thrust direction generated by controlling the thrust vector control servo are combined to construct a thrust vector control. As in the conventional fin control actuation systems, a servo control system can be used. In such a case, an autopilot can be used to follow the trajectory shaping and optimization commands and to stabilize the missile during flight. The advantage of this method is that it does not depend on the dynamic pressure of the atmosphere. On the other hand, a missile using the thrust vector control method becomes inoperative after motor burnout.

### 5.4.3 Control system modeling

The designs of the control system components—power sources, power transmission media, servos, and actuators of different missiles may vary considerably, but all have a common purpose, i.e., to convert autopilot commands into fin deflections.

For many purposes, regardless of the details of the control system design, the control system components can be aggregated and described by a simple control system model that uses transfer functions. The input to the model is the control-surface deflection command; the output is the control-surface deflection achieved. The relationship between the output and the input is defined mathematically by appropriate transfer functions and logical elements such as limits on the magnitudes of control-surface deflections. Transfer functions provide a powerful means of representing the operation of missile control systems in an aggregated form without the need for detailed simulation.

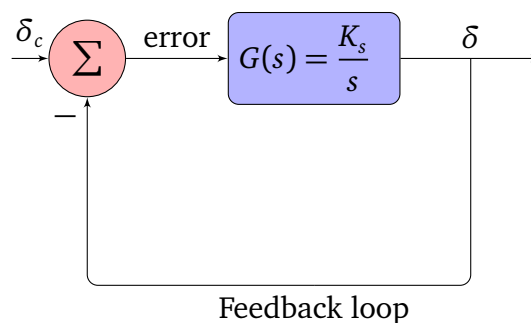

Figure 5.13: Closed loop diagram

By definition, the transfer function is equal to the ratio of the Laplace transform of the output of the system to the Laplace transform of the input, that is

$$\frac{\delta(s)}{\delta_c(s)} = G(s) \quad (5.3)$$

Where

$s$  = Is the Laplace variable

$\delta(s)$  = Laplace transform of the achieved control-surface deflection, rad(deg)

$\delta_c(s)$  = Laplace transform of the commanded control-surface deflection, rad(deg)

$G(s)$  = Control system transfer function, dimensionless.

Transfer functions can be obtained for a given control system by two methods. The first is by computation, i.e., start with the differential equations of the system and solve them for the desired ratio. The second method is by experimental measurement.

To illustrate the computation of the transfer function of a simple servo, it is assumed that the rate of fin deflection is proportional to the magnitude of the deflection command. The differential equation describing this servo is

$$\dot{\delta} = K_s \delta_c \quad (5.4)$$

Where

$K_s$  = servo system gain,  $s^{-1}$

$\delta$  = angular rate control-surface deflection, rad/s.

The Laplace transform of Eq 5.4 ignoring initial conditions is

$$s\delta(s) = K_s \delta_c(s) \quad (5.5)$$

Solving for the transfer function gives

$$\frac{\delta(s)}{\delta_c(s)} = \frac{K_s}{s} \quad (5.6)$$

Therefore, the transfer function is  $G(s) = \frac{K_s}{s}$  for a control system consisting of only the servo with no feedback.

Fig 5.13 shows the block diagram of a closed-loop control system in which the fin deflection achieved is fed back and compared with the input. For this case the input to the control servo is the difference between the output and the input to the control system. By a derivation, the transfer function for the entire closed-loop control system, not just the servo, is determined to be

$$G(s) = \frac{1}{1 + \tau s} \quad (5.7)$$

where  $\tau = \frac{1}{K_s}$ , control system time constant.

The response of the control system is modeled as a first order system.

## 5.5 Guidance laws

A guided missile engagement is a highly dynamic process. The conditions that determine how close the missile comes to the target are continuously changing, sometimes at a very high rate. A guidance sensor measures one or more parameters of the path of the missile relative to the target. A logical process is needed to determine the required flight path corrections based on the sensor measurements. This logical process is called a guidance law. The objective of a guidance law is to cause the missile to come as close as possible to the target. Guidance laws usually can be expressed in mathematical terms and are implemented through a combination of electrical circuits and mechanical control functions. The two basic criteria on which guidance laws are based are that the guidance must

- (1) be effective under anticipated conditions of use.
- (2) be able to be implemented using the particular sensor configuration selected.

A number of different schemes and their many variations have been used for missile guidance, chief among which are intercept point prediction, pursuit, beam-rider, proportional navigation, and methods based on modern control theory.

### 5.5.1 Beam rider or line of sight guidance

Command-to-line-of-sight guidance is similar to beam-rider guidance, in that both forms attempt to keep the missile within a guidance beam transmitted from the ground.

As shown in Figure 5.14, the vector  $e$  represents the error in missile position relative to the guidance beam at any given instant. This error is defined as the perpendicular distance from the missile to the centerline of the guidance beam. The missile guidance commands generated by beam-rider and command-to-line-of-sight systems are proportional to the error vector  $e$  and the rate of change of that vector  $\dot{e}$ . The proportionality with  $e$  causes the missile to be steered toward the center of the guidance beam; the proportionality with  $\dot{e}$  provides rate feedback, which causes the missile flight path to maneuver smoothly onto the centerline of the guidance beam without large overshoots.

A third parameter, the Coriolis acceleration  $A_{C_c}$ , may be included in the guidance equation. This Coriolis acceleration results from the angular rotation of the guidance beam. The Coriolis component of missile acceleration is required in order to allow the missile to keep up with the rotating beam as the missile flies out along the beam. In surface-to-air missile applications the angular rate of the guidance beam is typically great enough to cause this parameter to be significant.

Equations for calculating the guidance parameters will be given and the method of combining them to form the missile commanded-lateral-acceleration vector also  $a_c$ .

The equation for calculating  $e$  is

$$e = P_B - P_M \quad (5.8)$$

where

$e$  = vector of error in missile position relative to the guideline, m

$P_B$  = position vector of a point on the guideline at the point of intercept with the error vector  $e$ , m

$P_M$  = position vector of the missile, m.

The vector  $P_B$  should be written in terms of the guideline and the missile position vector  $P_M$

$$P_B = (u_{gl} \cdot P_M)u_{gl} \quad (5.9)$$

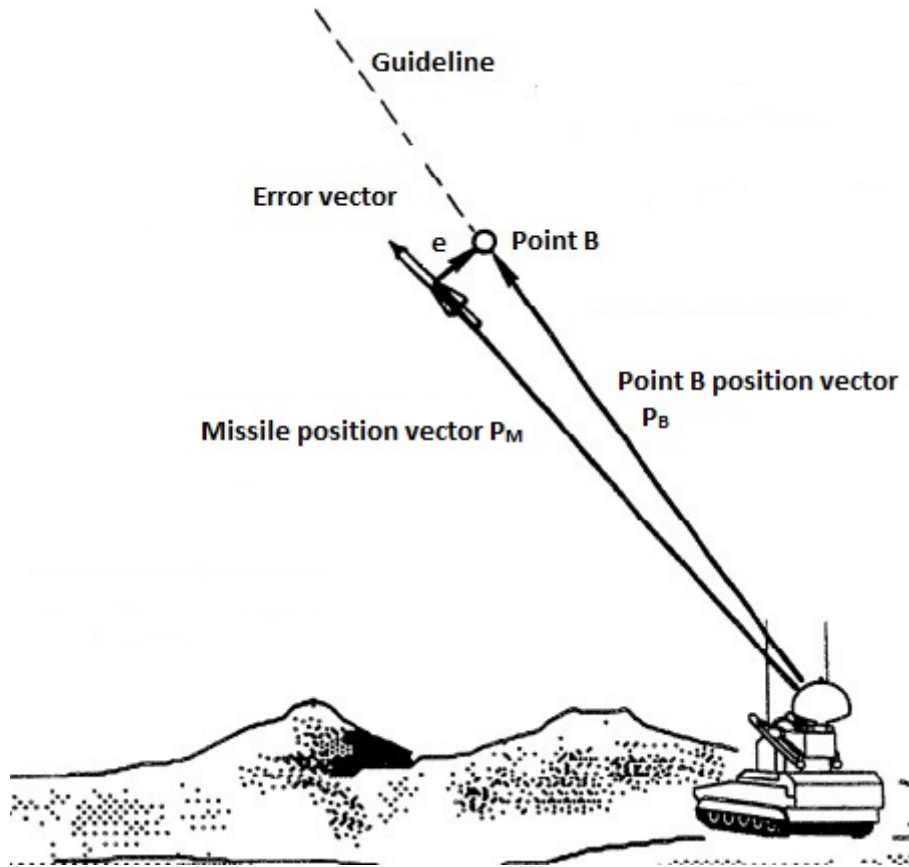

Figure 5.14: Guidance Error for Beam Rider or Command to Line of Sight

where

$u_{gl}$  = unit vector that represents the direction of the guideline.

The error rate vector  $\dot{e}$  is calculated as the difference between the component of missile velocity  $V_M$  perpendicular to the guideline and the component of the velocity of point B perpendicular to the guideline. The error rate vector  $\dot{e}$  is given by

$$\dot{e} = V_{B_{perp}} - V_{M_{perp}} \quad (5.10)$$

The components of velocities, for substitution into Eq 5.10 are given by using

$$\begin{cases} V_{B_{perp}} = \omega_{gl} \times P_B \\ V_{M_{perp}} = (u_{gl} \times V_M) \times u_{gl} \end{cases} \quad (5.11)$$

where

$\omega_{gl}$  = angular rate vector of the guideline, rad/s.

The Coriolis acceleration term  $A_{C_c}$  is calculated using

$$A_{C_c} = \text{Mag}[\omega_{gl} \times (V_M \cdot u_{gl})u_{gl}] \quad (5.12)$$

$\text{Mag}[\ ]$  = the magnitude of the argument vector.

Finally, using the terms calculated in Eqs.5.8, 5.10, and 5.12 the commanded-lateral-acceleration vector, to guide the missile onto the centerline of the guide beam, is given by

$$a_c = k_1 e u_e + k_2 \dot{e} u_e + k_3 A_{C_c} u_c \quad (5.13)$$

where

$k_1$ ,  $k_2$  and  $k_3$  are proportionality constants (gains)

$u_c$  = unit vector in the direction of the component of  $\mathbf{e}$  that is perpendicular to the missile centerline. The Eq 5.13 represents the commanded-lateral-acceleration vector that is fed to the control system to produce the convenient deflection to minimize the error  $\mathbf{e}$ .

The choice of the proportionality constants  $k_1$ ,  $k_2$  and  $k_3$  is done in the simulation chapter using the **PSO** algorithm to minimize as possible the miss distance.

## 5.5.2 Proportional navigation

Proportional Navigation is the most widely known and used guidance law for short- to medium-range homing missiles, because of its inherent simplicity and ease of implementation. Proportional navigation is so robust, however, that acceptable miss distances can be achieved even against targets that perform relatively severe evasive maneuvers if the missile response time is short enough and if the missile is capable of sufficient acceleration in a lateral maneuver.

Simply stated, classical proportional navigation guidance is based on recognition of the fact that if two bodies are closing on each other, they will eventually intercept if the line of sight (**LOS**) between the two does not rotate relative to the inertial space. More specifically, the **PN** guidance law seeks to null the **LOS** rate against nonmaneuvering targets by making the interceptor missile heading proportional to the **LOS** rate. For instance, in flying a proportional navigation course, the missile attempts to null out any line-of-sight rate that may be developing. The missile does this by commanding wing deflections to the control surfaces. Consequently, these deflections cause the missile to execute accelerations normal to its instantaneous velocity vector. Thus, the missile commands  $g$ 's to null out measured **LOS** rate [1].

The relation describing the the commanded normal (or lateral) acceleration can be expressed as follows:

$$a_c = NV_c \frac{d\lambda}{dt} \quad (5.14)$$

where

$a_c$  = the commanded normal (or lateral) acceleration [ft/sec<sup>2</sup>] or [m/sec<sup>2</sup>],

$N$  = the navigation constant (also known as navigation ratio, effective navigation ratio, and navigation gain), a positive real number [dimensionless],

$V_c$  = the closing velocity [ft/sec] or [m/sec],

$\frac{d\lambda}{dt}$  = the LOS rate measured by the missile seeker [rad/sec].



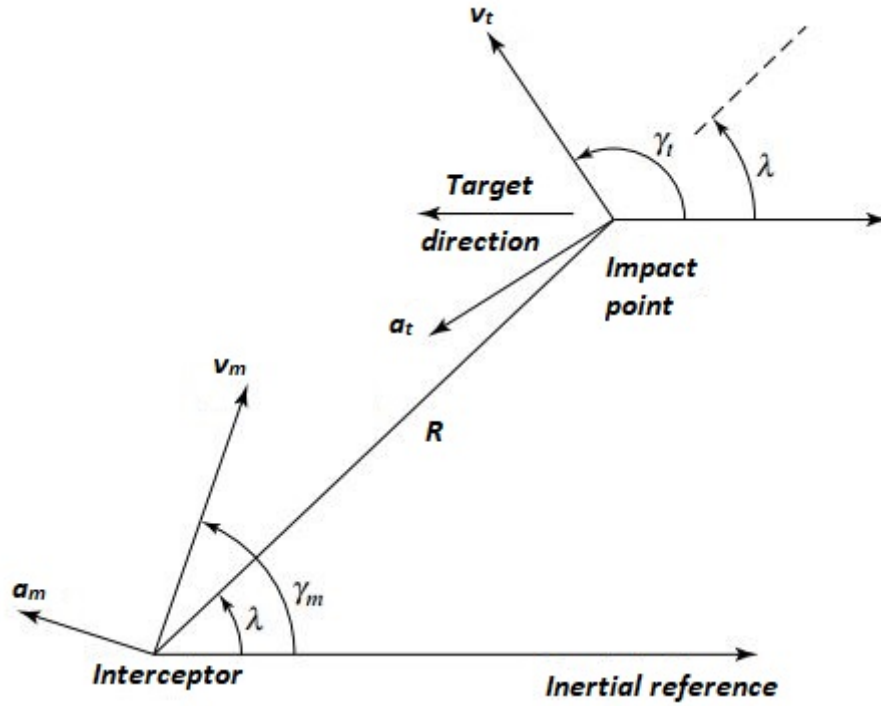

Figure 5.15: Geometry for derivation of proportional navigation.

Figure 5.15 shows the geometry from which the equations representing proportional navigation can be derived. In the derivation of the proportional navigation equations, it will be assumed that the missile speed and target speed remain constant during the time of flight of the missile; this is normally a good assumption.

From the engagement geometry of Figure 5.15, we note that the range between the missile and the target has a value  $R$ , and the line of sight has rotated through an angle  $\lambda$  from the initial value. The rate of rotation of the line of sight at any time is given by the difference in the normal components of velocity of the target and missile, divided by the range. This can be expressed by the equation

$$R \left( \frac{d\lambda}{dt} \right) = v_t \sin(\gamma_t - \lambda) - v_m \sin(\gamma_m - \lambda), \quad (5.15)$$

while the velocity component along the line of sight is given by the equation

$$\frac{dR}{dt} = v_t \cos(\gamma_t - \lambda) - v_m \cos(\gamma_m - \lambda) \quad (5.16)$$

where

$R$  = range between missile and target,

$v_m$  = interceptor missile velocity,

$v_t$  = velocity of the target,

$\lambda$  = line-of-sight (LOS) angle,

$\gamma_m$  = missile flight path (or heading) angle, that is, angle between the missile velocity vector and inertial reference,

$\gamma_t$  = target flight path angle.

The proportional navigation guidance law states that the rate of change of the missile heading ( $\gamma_m$ ) is directly proportional to the rate of change of the line-of-sight angle ( $\lambda$ ) from the missile to the target. Therefore, the basic differential equation for this case is given by

$$\frac{d\gamma_m}{dt} = N \frac{d\lambda}{dt}, \quad (5.17)$$

where  $N$  is the navigation constant (see also 5.14). Equations 5.15, 5.16, and 5.17 represent the complete equations of motion for the system. The dependent variables are  $R$ ,  $\gamma_m$ , and  $\lambda$ ; the velocities  $v_m$ ,  $v_t$  and the target's flight path angle  $\gamma_t$  must be known or assumed. The usual means of implementing a proportional navigation guidance system is to use the target tracker (or seeker) to measure the line-of-sight rate ( $\frac{d\lambda}{dt}$ ).

We will now develop the general proportional navigation guidance equation. In order to do this, we begin by differentiating 5.15, yielding

$$\dot{R}\dot{\lambda} + R\ddot{\lambda} = (\dot{\gamma}_t - \dot{\lambda})v_t \cos(\gamma_t - \lambda) - (\dot{\gamma}_m - \dot{\lambda})v_m \cos(\gamma_m - \lambda) \quad (5.18a)$$

$$\dot{R}\dot{\lambda} + R\ddot{\lambda} = \dot{\gamma}_t v_t \cos(\gamma_t - \lambda) - \dot{\gamma}_m v_m \cos(\gamma_m - \lambda) - \dot{\lambda}[v_t \cos(\gamma_t - \lambda) - v_m \cos(\gamma_m - \lambda)]. \quad (5.18b)$$

Substituting (5.16) and (5.17) into (5.18b), we obtain

$$2\dot{R}\dot{\lambda} + R\ddot{\lambda} = \dot{\gamma}_t \cos(\gamma_t - \lambda) - N\dot{\lambda}v_m \cos(\gamma_m - \lambda) \quad (5.19)$$

or

$$\frac{d^2\lambda}{dt^2} + \left(\frac{\dot{\lambda}}{R}\right)[2\dot{R} + Nv_m \cos(\gamma_m - \lambda)] = \frac{1}{R}\dot{\gamma}_t v_t \cos(\gamma_t - \lambda) \quad (5.20)$$

In the above derivation, we note that the equation system consisting of (5.16), (5.17), and (5.20) constitutes the proportional navigation guidance in the plane. We will now investigate the case whereby the target flies a straight-line course. For a straightline course, the target's flight path angle rate in (5.20) is zero; that is,  $\frac{d\gamma_t}{dt} = 0$ . Therefore, with this condition we have a homogeneous differential equation for  $\frac{d\lambda}{dt}$ . Now, in order for  $\frac{d\lambda}{dt}$  to approximate the zero line,  $\frac{d\lambda}{dt}$  and  $\frac{d^2\lambda}{dt^2}$  must have different signs. Thus, we have the inequality

$$2\left(\frac{dR}{dt}\right) + Nv_m \cos(\gamma_m - \lambda) > 0, \quad (5.21)$$

since by definition  $R > 0$ . From (5.21), we obtain the navigation ratio  $N$  as

$$N > \left\{-2\left(\frac{dR}{dt}\right)/v_m \cos(\gamma_m - \lambda)\right\} \text{ for } \cos(\gamma_m - \lambda) > 0. \quad (5.22)$$

The condition  $\cos(\gamma_m - \lambda)$  means that the missile's direction of flight forms an angle with the LOS to the target. Substituting  $\frac{dR}{dt}$  from (5.16) into (5.22), one obtains

$$N > 2\{1 - [\cos(\gamma_t - \lambda)/(\kappa \cos(\gamma_m - \lambda))]\} \quad (5.23)$$

where we have substituted  $\kappa = v_m/v_t$ . We can now write (5.23) as

$$\begin{aligned} N &= N' \{1 - [\cos(\gamma_t - \lambda)/(\kappa \cos(\gamma_m - \lambda))]\} \\ &= -N' \left\{\left(\frac{dR}{dt}\right)/v_m \cos(\gamma_m - \lambda)\right\} \end{aligned} \quad (5.24)$$

or

$$N' = -N \left\{v_m \cos(\gamma_m - \lambda)/\left(\frac{dR}{dt}\right)\right\} \quad (5.25)$$

where  $N'$  ( $N' > 2$ ) is commonly called the *effective navigation ratio*, and  $-\frac{dR}{dt}$  is the missile's closing velocity (i.e.,  $-\frac{dR}{dt} = v_c$ ). We note from (5.20) that when  $\frac{d^2\lambda}{dt^2}$  remains finite, then as  $R \rightarrow 0$ ,  $\left(\frac{d\lambda}{dt}\right) \rightarrow 0$  also.

Since the missile velocity vector cannot be controlled directly, the missile normal acceleration  $a_n$  or  $a_c$  is defined as

$$a_c = v_m \frac{d\gamma_t}{dt}, \quad (5.26)$$

where  $\frac{d\gamma_t}{dt}$  is the missile's turning rate. Substituting (5.17) into (5.26), we have

$$a_c = v_m \frac{d\gamma_t}{dt} = v_m N \left( \frac{d\lambda}{dt} \right). \quad (5.27)$$

Furthermore, substituting (5.24) into (5.27) results in

$$a_c = \left\{ -N \dot{R} v_m / (v_m \cos(\gamma_m - \lambda)) \right\} \left( \frac{d\lambda}{dt} \right) = \{ N v_c / \cos(\gamma_m - \lambda) \} \left( \frac{d\lambda}{dt} \right) \quad (5.28)$$

where the closing  $v_c$  is equal to  $-\left(\frac{dR}{dt}\right)$ , and  $N$  is given in terms of (5.24). Equation (5.28) is the well-known general classical proportional navigation guidance equation and is similar to (5.14). This equation is used to generate the guidance commands, with the missile velocity expressed in terms of the closing velocity  $v_c$  (between the missile and the target) and the seeker gimbal angle  $(\gamma_m - \lambda)$ . For more details see [1].

### 5.5.3 Proportional derivative based guidance law

Model-based PID control synthesis is a typical low-order controller design problem. The three control blocks in the PID control have different actions in the process. A proportional controller  $K_p$  has the effect of reducing the rise time and will reduce, but never eliminate, the steady-state error. An integral control  $K_i$  has the effect of eliminating the steady-state error, but it may make the transient response worse. A derivative control  $K_d$  has the effect of increasing the stability of the system, reducing the overshoot and improving the transient response [27].

The expression for the output of the PID controller in terms of the error and the corresponding transfer function are given as

$$u(t) = K_p \left( e(t) + \tau_d \frac{de(t)}{dt} + \frac{1}{\tau_i} \int_0^t e(\tau) d\tau \right) \quad (5.29)$$

The figure 5.16 shows the structure of a PID controller.

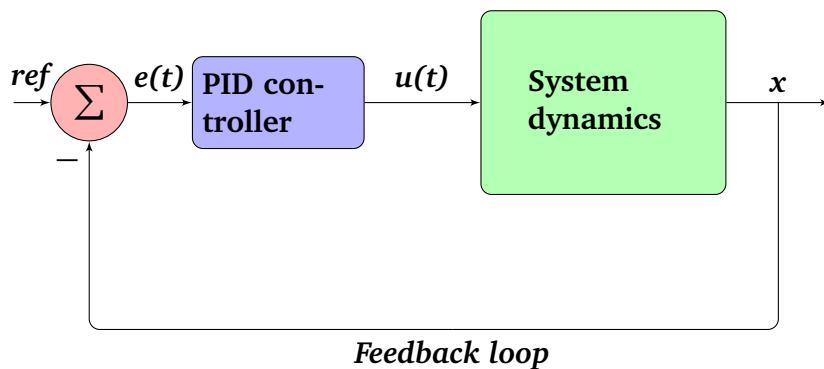

Figure 5.16: PID controller block diagram.

In the simulation chapter where PD method implemented we've assumed that the missile and target positions are known, thus we've defined the normal acceleration to be

$$a_c = K_p \text{sgn}(E) + K_d \text{sgn}(\dot{E}) + K_c \quad (5.30)$$

where

$K_p, K_d, K_c =$  proportionality gains  $\in \mathbb{R}^{2 \times 3}$ ,

$$K_p = \begin{bmatrix} k_{p11} & k_{p12} & k_{p13} \\ k_{p21} & k_{p22} & k_{p23} \end{bmatrix}, K_d = \begin{bmatrix} k_{d11} & k_{d12} & k_{d13} \\ k_{d21} & k_{d22} & k_{d23} \end{bmatrix}, K_c = \begin{bmatrix} k_{c11} & k_{c12} & k_{c13} \\ k_{c21} & k_{c22} & k_{c23} \end{bmatrix}$$

$E =$  Range vector defined as follows,

$$E = \begin{bmatrix} E_x = P_T(x) - P_M(x) \\ E_y = P_T(y) - P_M(y) \\ E_z = P_T(z) - P_M(z) \end{bmatrix}$$

$\dot{E} =$  Range vector derivative is given by

$$\dot{E} = \begin{bmatrix} \dot{E}_x = \dot{P}_T(x) - \dot{P}_M(x) \\ \dot{E}_y = \dot{P}_T(y) - \dot{P}_M(y) \\ \dot{E}_z = \dot{P}_T(z) - \dot{P}_M(z) \end{bmatrix}$$

$P_T =$  Target position vector expressed in earth coordinate system,

$P_M =$  Missile position vector expressed in earth coordinate system.

- **Sign function:** In mathematics, the sign function is an odd mathematical function that extracts the sign of a real number. In mathematical expressions the sign function is often represented as **sgn**, see ( figure 5.17 ).

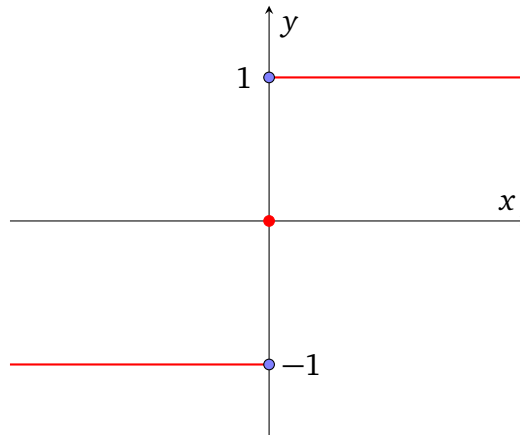

Figure 5.17: Sign function  $y = \text{sgn}(x)$ .

The reason behind the use of the **sgn** function in equation ( 5.30 ) is to eliminate the chattering effect due to the presence of unmodeled dynamics in the system which may steer the system into instability. With this function we obtain a smooth continuous control signal.

## 5.5.4 Optimisation techniques applied to guidance laws

### 5.5.4.1 Introduction

Optimisation methods are widely used in various fields. The task is to choose the best or a satisfactory one from amongst the feasible solutions to an optimisation problem. The process of using optimisation methods to solve a practical problem mainly involves these two steps. First, formulate the optimisation problem which involves determining the decision variables, objective function and constraints, and possibly an analysis of the optimisation problem. Second, select an appropriate numerical method, solve the optimisation problem, test the optimal solution and make a decision accordingly. Mathematically, an optimisation problem may be summarised as follows

$$\max(f(x)) \quad \text{or} \quad \min(f(x)) \quad (5.31)$$

where

$f(x)$  is the objective function

$x$  is an  $N$ -dimensional vector consisting of the decision variables.

### 5.5.4.2 PSO algorithm

Swarm intelligence refers to a class of algorithms that simulates natural and artificial systems composed of many individuals that coordinate using decentralised control and self-organisation. The algorithm focuses on the collective behaviours that result from the local interactions of the individuals with each other and with the environment where these individuals stay. Some common examples of systems involved in swarm intelligence are colonies of ants and termites, fish schools, bird flock, animal herds [25].

The particle swarm optimisation (PSO) algorithm falls into the category of SI algorithms and is a population-based optimisation technique originally developed by Kennedy and Eberhart in 1995.

In PSO algorithm, Each agent is treated as a particle with infinitesimal volume with its properties being described by the current position vector, its velocity vector and the personal best position vector. Each agent knows the global best particle ( $gbest$ ) between all the best particles ( $pbests$ ).

1. **Velocity vector:** denotes the increment of the current position.

It is given for each agent or (particle) by

$$v_i^{k+1} = \sigma v_i^k + c_1 rand_1 \times (pbest_i - s_i^k) + c_2 rand_2 \times (gbest_i - s_i^k) \quad (5.32)$$

where

$v_i^k$  = agent  $i$  current velocity at the  $k^{th}$  iteration,

$\sigma$  = inertia weight or (weighting function),

$c_j$  = inertia weight factor,

$rand$  = random number between 0 and 1,

$s_i^k$  = agent  $i$  current position at the  $k^{th}$  iteration,

$pbest$  =  $i^{th}$  agent's best position,

$gbest$  = group's best position.

2. **Inertia weight:** is given as follows

$$\sigma = \sigma_{max} - \frac{\sigma_{max} - \sigma_{min}}{iter_{max}} \times iter \quad (5.33)$$

The equation 5.33 is called the "Inertia Weights Approach(IWA)".

3. **Position vector**: is modified according to the following equation

$$s_i^{k+1} = s_i^k + v_i^{k+1} \quad (5.34)$$

where

$s_i^k$  = agent current position,

$s_i^{k+1}$  = agent modified position,

$v_i^{k+1}$  = agent modified velocity.

PSO concepts presented above are illustrated in the following flow diagram 5.18.[26]

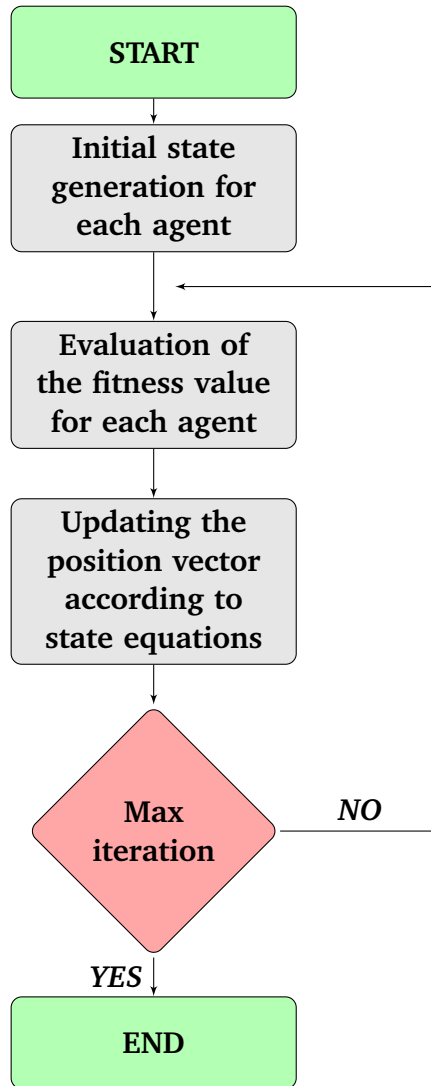

Figure 5.18: PSO diagram

In the simulation chapter we've used this optimisation technique and we've defined the miss distance to be the function subject to the minimisation. A matlab code of the PSO algorithm is provided in the appendices.

# Chapter 6

## Application of guidance laws to a generic surface to air missile

---

### 6.1 Introduction

A simulation is based on mathematical models of the missile, target and environment, and these mathematical models consist of equations that describe physical laws and logical sequences. The missile model includes factors such as missile mass, thrust aerodynamics, guidance and control, and the equations necessary to calculate the missile attitude and flight path. The target model is often less detailed but includes sufficient data and equations to determine the target flight path. The model of the environment contains, at a minimum, the atmospheric characteristics and gravity.

### 6.2 Program structure

In a digital simulation the processing is done in discrete time steps, the size of which must be carefully considered to ensure faithful representation of the highest frequency components of the simulated missile system. At any given time step the processing proceeds through each task and calculates any changes that occur within that time increment. After completion of all tasks appropriate to that time increment, the program steps to the next time increment and repeats the cycle. This last is described in the following diagram that shows the flow of processing from one task to the next.

Each block in the diagram represents a major function, or group of functions, or a major logic process in the computer program (see figure 6.1). The direction of processing flow is indicated by arrows. One cycle through the flow diagram represents an incremental time step.

Missile and target position and velocity vectors are used to calculate the relative position and velocity vectors with respect to the target. A test is performed to determine whether the missile has reached its closest approach to the target, which of course will not occur until the end of the engagement. If the test shows that the closest approach has been reached, the program sequence is diverted to a routine that calculates miss distance and the program ends. Otherwise, the program continues into the guidance routine.

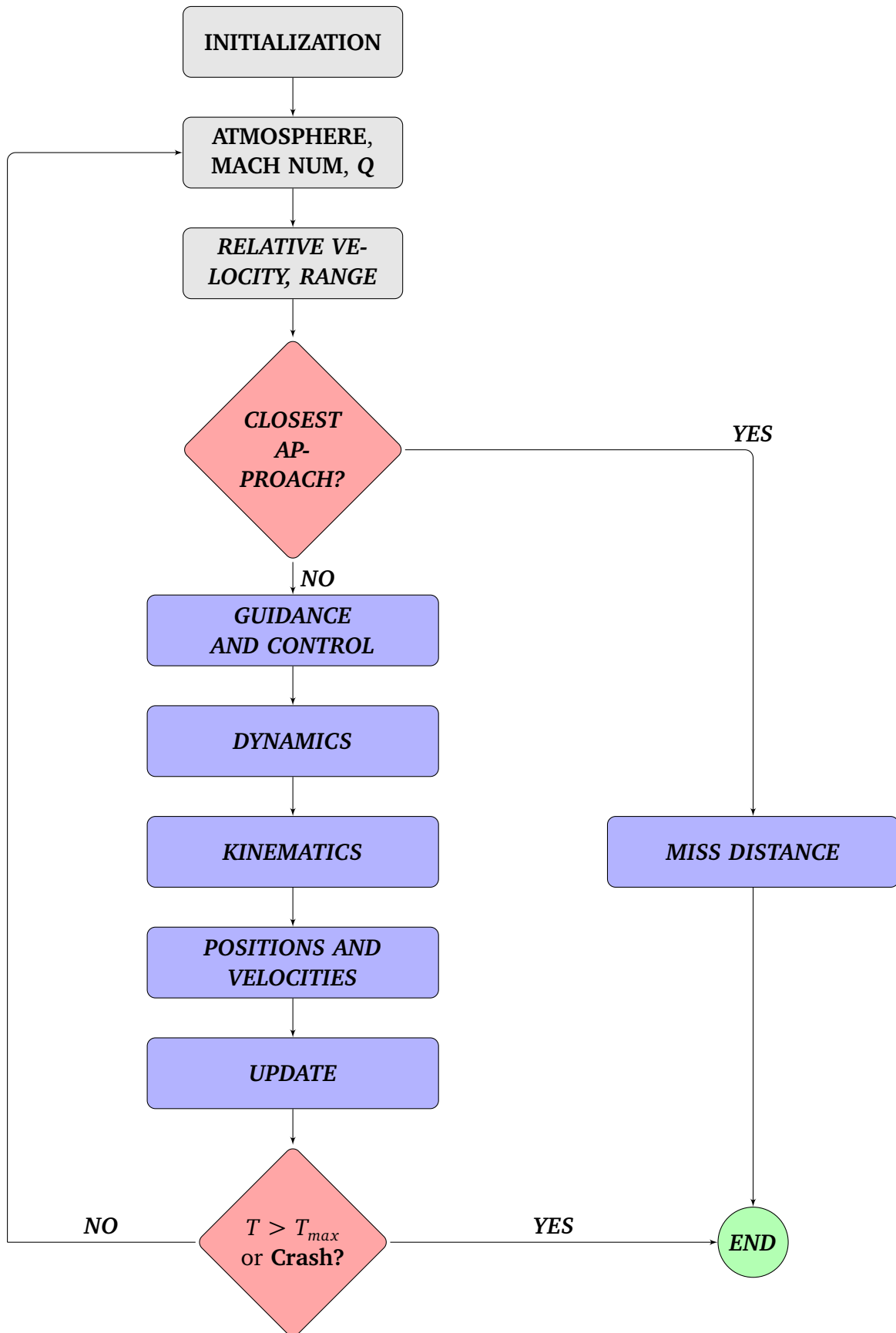

Figure 6.1: Diagram for computaional cycle of missile flight simulation

For purposes of illustration it is assumed that a particular missile configuration is to be investigated. The missile configuration to be studied is controlled by torque-balanced canard control



surfaces, and the canards and stabilizing tail fins are arranged in a cruciform configuration. The description of the missile required for the simulation model is given in the paragraphs that follow.

- **Mass:**

$m_0 = 85.0$ , missile mass at launch [Kg]

$m_{b0} = 57.0$ , missile mass at burnout [Kg]

The equation describing the mass variation in the corresponding missile simulation example is given by:

$$m = m_0 - \frac{1}{I_{sp}} \int F_{p_{ref}} dt, \quad kg \quad (6.1)$$

$I_0 = 61$ , moment of inertia about x,y and z axes at launch [ $Kg.m^2$ ]

$I_{b0} = 47$ , moment of inertia about x,y and z axes at launch [ $Kg.m^2$ ]

The moment of inertia varies linearly with the mass:

$$I = I_0 - (I_0 - I_{b0}) \left( \frac{m_0 - m}{m_0 - m_{b0}} \right), \quad kg.m^2 \quad (6.2)$$

$x_{cm_{b0}} = 1.55$ , distance from nose to center of mass at launch [m]

$x_{cm_b} = 1.35$ , distance from nose to center of mass at burnout [m]

The location of the center of mass varies also linearly with the mass, it is given as follows:

$$x_{cm} = x_{cm_0} - (x_{cm_0} - x_{cm_{b0}}) \left( \frac{m_0 - m}{m_0 - m_{b0}} \right), \quad m \quad (6.3)$$

- **Propulsion:**

$t_{b0} = 5.6$ , time of burnout

$P_{ref} = 101314$ , ambient pressure (Pa)

$A_e = 0.011$ , exit area of rocket nozzle ( $m^2$ )

$I_{sp} = 2224$ , specific impulse (N.s/Kg)

Evolution of thrust in time			
Time (s)	Thrust (N)	Time (s)	Thrust (N)
0	0	3.5	14700
0.01	450	3.8	14300
0.04	17800	4	12900
0.05	23100	4.1	11000
0.08	21300	4.3	7000
0.1	20000	4.5	4500
0.2	18200	4.7	2900
0.3	17000	4.9	1500
0.6	15000	5.2	650
1	13800	5.6	0
1.5	13300	100	0
2.5	13800		

- **Aerodynamics:**

$S = 0.0127$ , missile aerodynamic reference area,  $m^2$

$d = 0.127$ , aerodynamic reference length,  $m$

$x_{ref} = 1.35$ , distance from nose to reference moment station,  $m$

<i>Coefficients / Mach number</i>	0	0.8	1.14	1.75	2.5	3.5
$C_{D0}$	0.8	0.8	1.2	1.15	1.05	0.94
$C_{L\alpha}$	38	39	56	55	40	33
$C_{m\alpha}$	-160	-170	-185	-235	-190	-150
$C_{m\delta}$	180	250	230	130	80	45
$C_{m_q} + C_{m_{\dot{\alpha}}}$	-6000	-13000	-16000	-13500	10000	-6000
$k$	0.0255	0.0305	0.0361	0.0441	0.0540	0.0665

### 6.3 Simulation of a missile launch

In this section, we present all the simulation results obtained when simulating the missile launch, without acting on the fins (no deflection is made), in order to visualize missile parameters variations and its trajectory.

- Inputs for open loop simulation

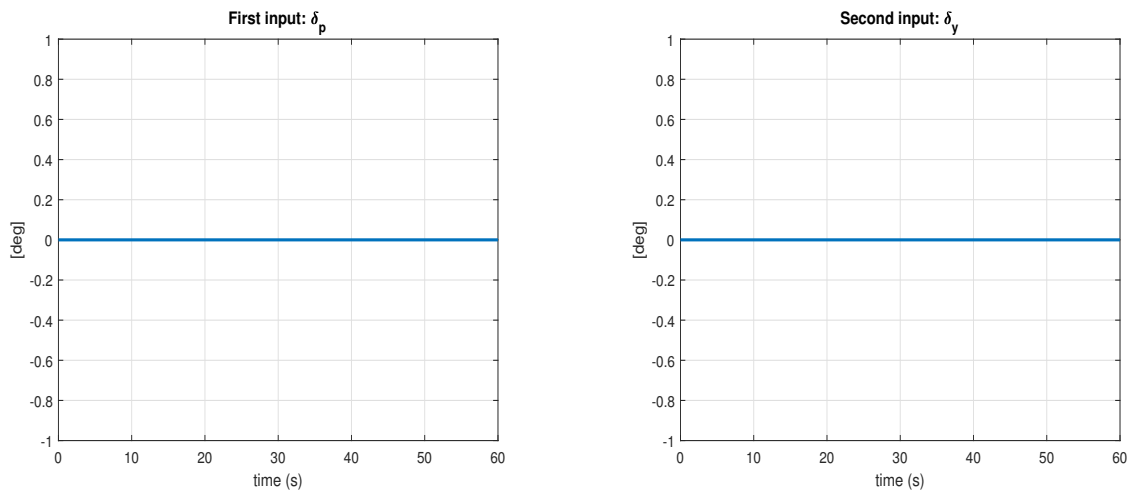

Figure 6.2: Input for open loop simulation

- Thrust variation

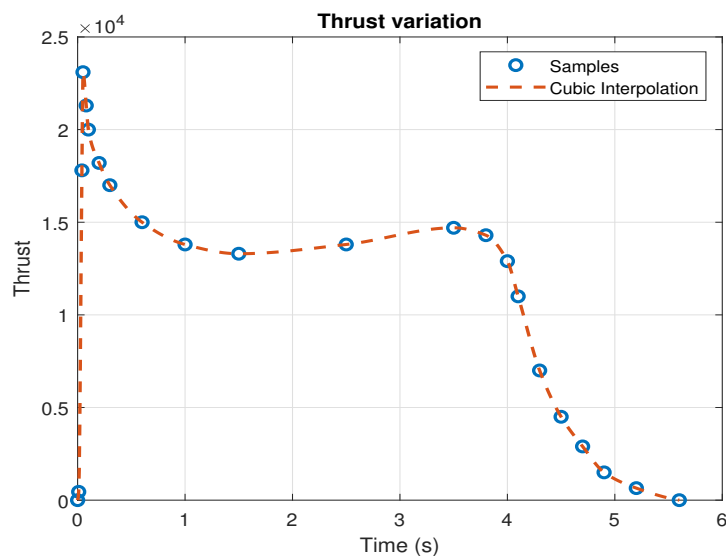

Figure 6.3: Thrust variation.

The figure 6.3 shows that the missile attains its peak of thrust at the first instants of its flight because the missile need a maximum of energie to fly so far as possible with highest velocity. At this point the thrust begins to decrease under the influence of the resistance of the air versus the missile.

- **Mass variation**

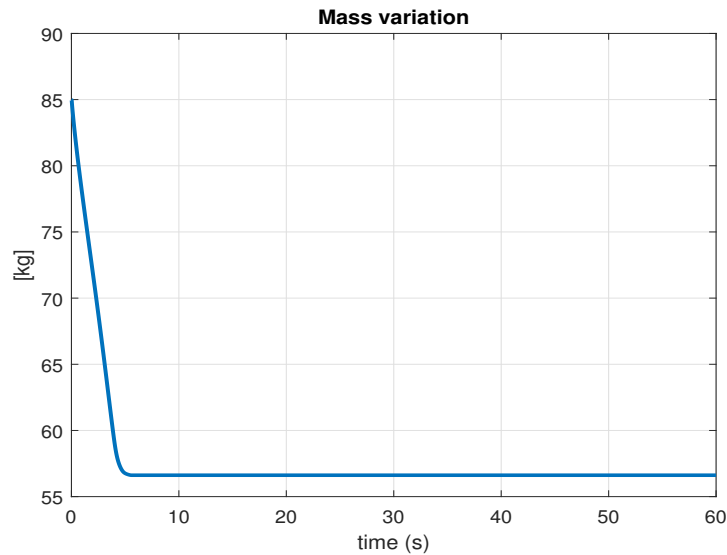

Figure 6.4: Mass variation

The Figure 6.4 illustrates the change in mass of the missile during its flight. As the figure shows, we can decompose the missile mass evolution into tow phases :

**Phase 01** : begins at the instnant of luanch to 5.6 s, in this interval, we can see that the mass of the corresponding missile decrease from 85 kg to 57 kg, however, this decreasing is refered to the consumption of the propellant during the flight.

**Phase 02** : this phase is the last time of simulation, where the mass become constant (i.e : no thrust, no fuel consumption), the missile fly only with its propre mass.

- **Ienrtia variation**

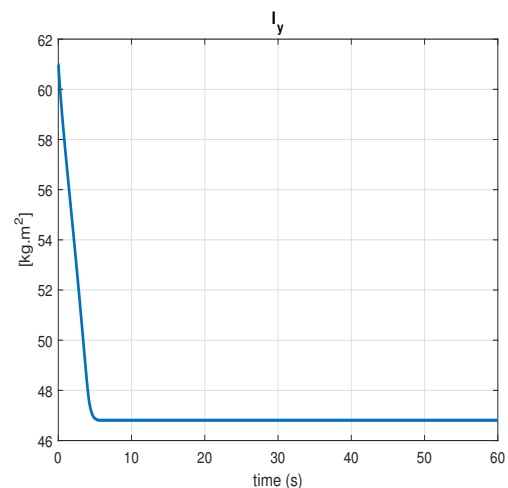
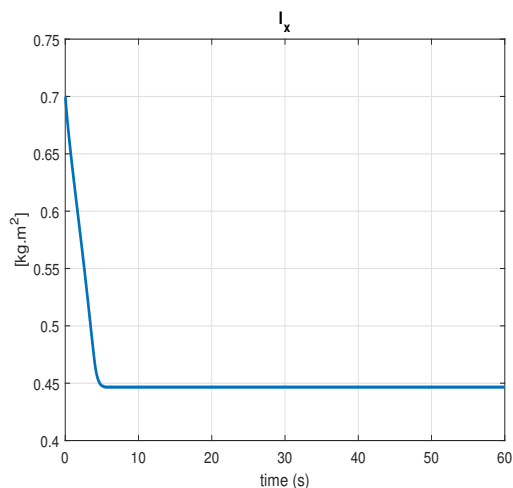

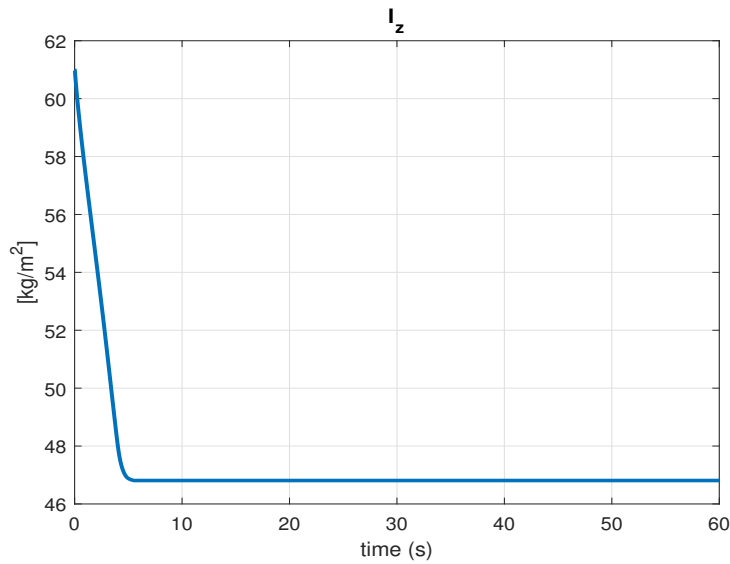

Figure 6.5: Inertia variation on  $x$ ,  $y$  and  $z$  axes respectively

This figures show the evolution of inertia moment on  $x$ ,  $y$  and  $z$  axes respectively, this variation is related linearly with changing in mass by a mathematical equation described in the missile modeling chapter.

- **Center of mass variation**

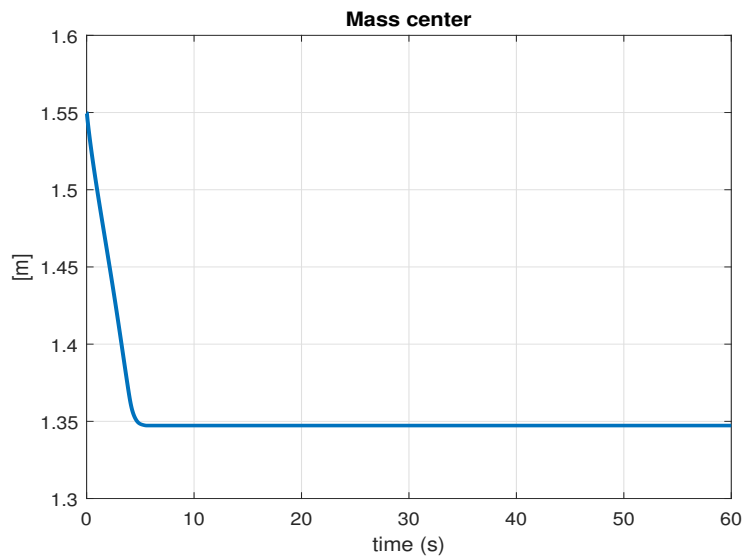
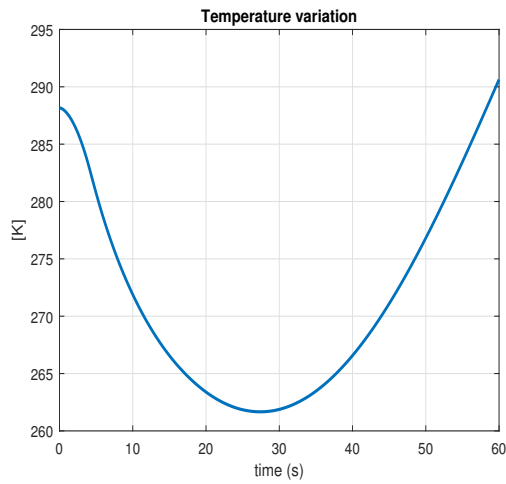

Figure 6.6: Center of mass variation

As the missile mass changes, the position of the center of mass also changes linearly with it.

- Atmospheric parameters



(a) Temperature variation

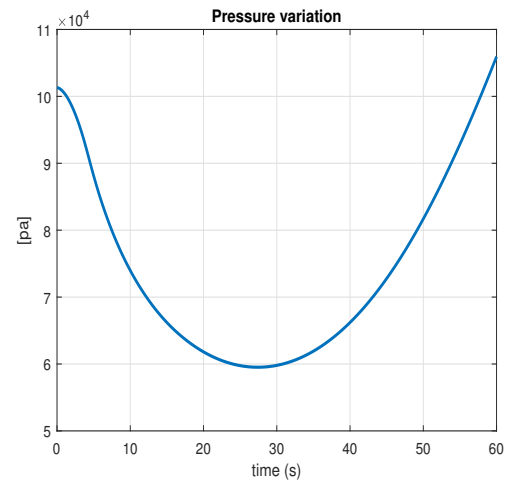

(b) Pressure variation

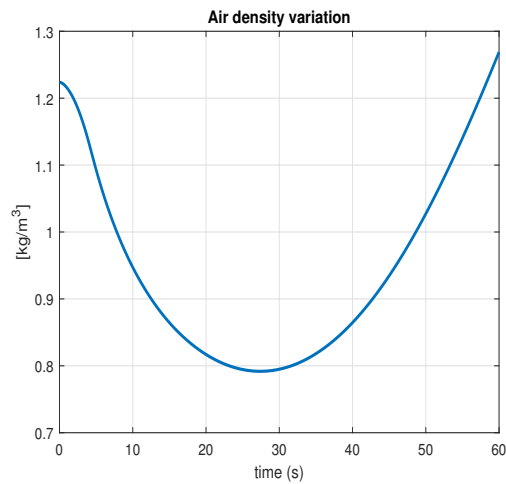

(c) Air-density variation

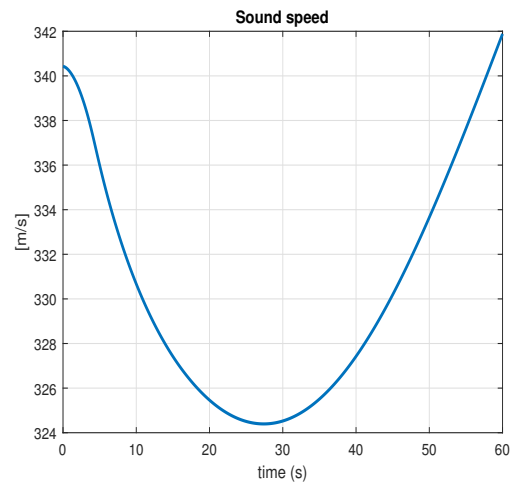

(d) Speed of sound variation

Figure 6.7: Evolution of atmospheric parameters.

The previous figures 6.7 (a, b, c and d) show the evolution of the atmospheric parameters during the missile flight. As the missile's altitude increase the atmospheric parameters decrease on the first half time of flight until the missile gets its highest level of altitude. However, these parameters increase in the second half of flight because the missile's altitude decrease. So these parameters are inversely proportional with missile's altitude.

- Mach number variation

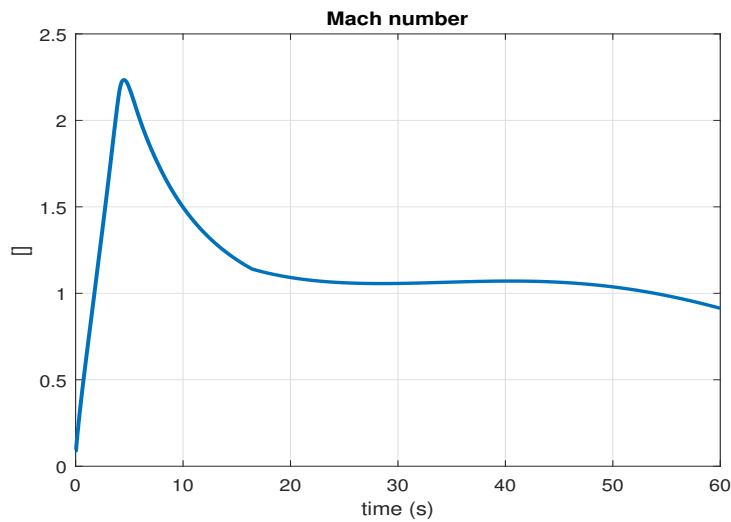

Figure 6.8: Mach number variation

Figure 6.8 presents the evolution of Mach number during the flight as function of time, it is clearly seen that the Mach number increases rapidly in the first 5 s until its highest value (Mach = 2.3 at  $t=5.6$  s), this refers to the enormous thrust of missile at the beginning of its flight. After this point the missile Mach number begins to decrease because of the termination of thrust.

- Gravity variation

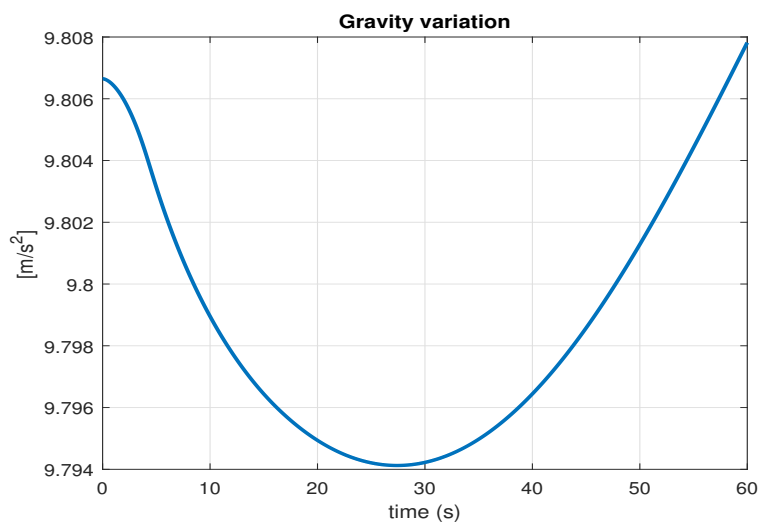

Figure 6.9: Gravity variation

Figure 6.9 corresponds to the gravity variation during the missile flight. It shows a little variation which can be neglected, the gravity variation is also inversely proportional to the missile's altitude.

- Lift and Drag force variation

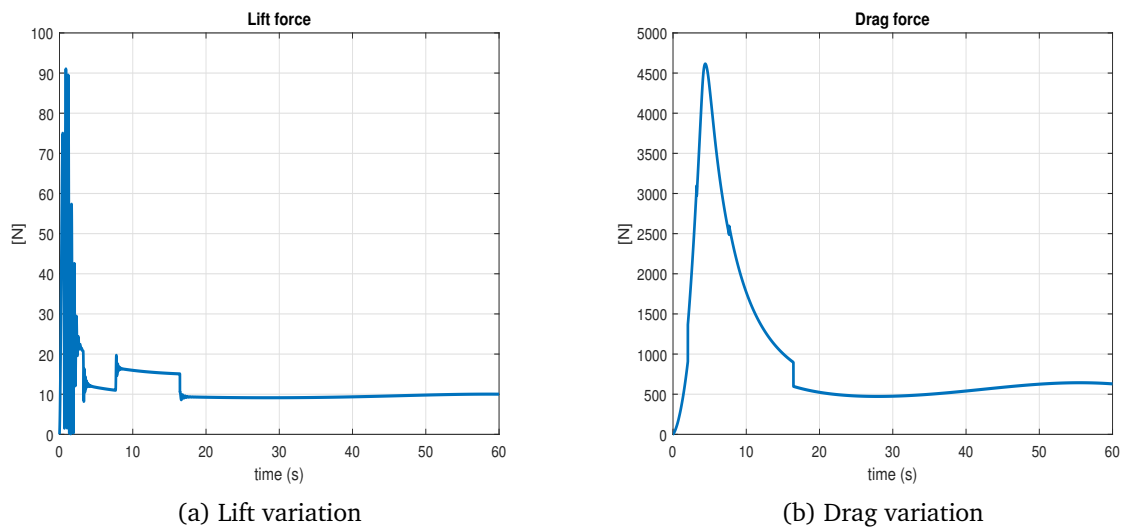

Figure 6.10: Evolution of Lift and Drag forces.

- Angle of attack variation

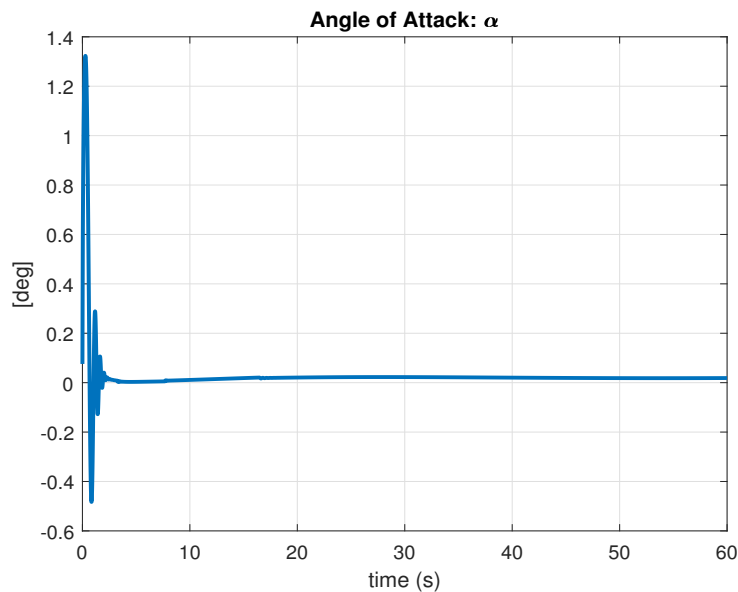

Figure 6.11: Angle of attack variation

Figure 6.11 shows the behavior of the angle of attack during the flight. It can be seen that, there is some variation in the first 3 s, due to the increasing in drag force under the influence of the viscosity of the air which perturbs the missile motion.

- Side-slip angle variation

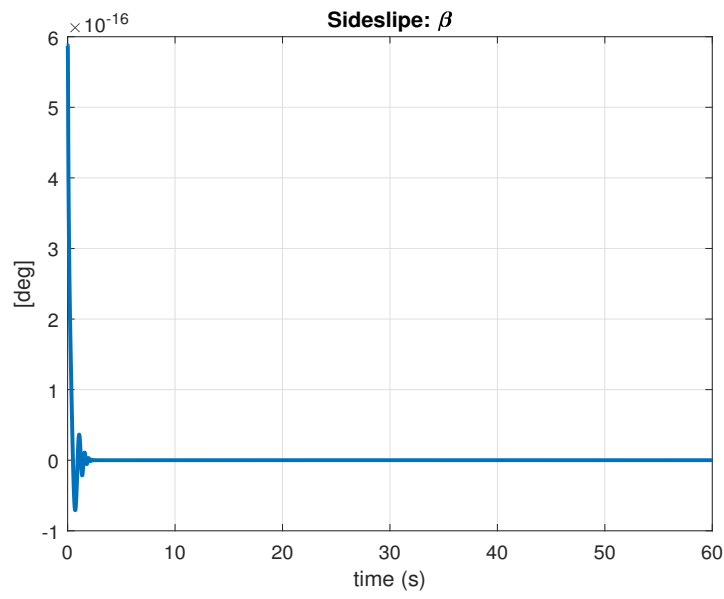

Figure 6.12: Side-slip angle variation.

- Total angle of attack variation

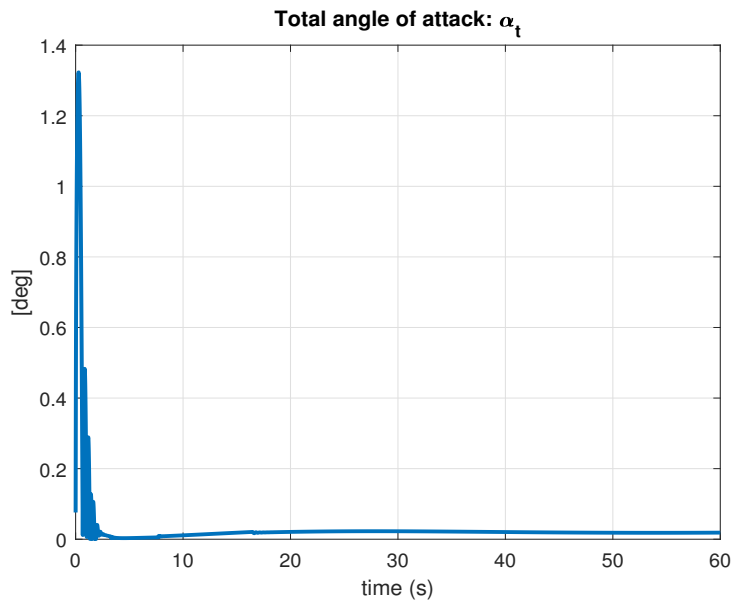

Figure 6.13: Total angle of attack variation.



- Pitch and Yaw moments variation

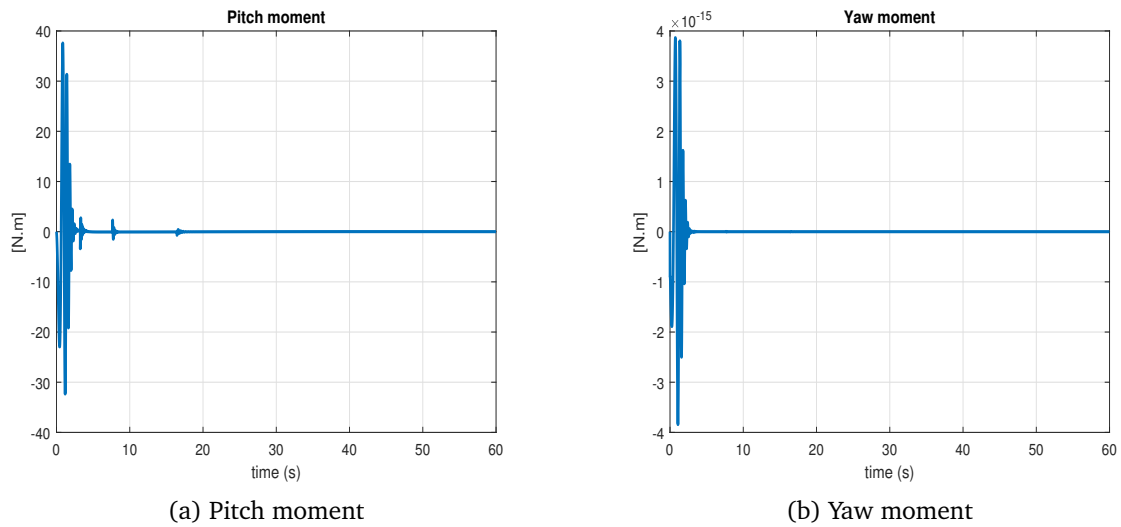

Figure 6.14: Pitch and Yaw moments variation.

Figure 6.14 illustrates the variation of pitch and yaw rotational moments of missile, where the pitch moment is caused by the variation in the angle of attack during the first 5 s of flight. The yaw moment is zero during the whole flight because there is no damping effect on the missile (side-slip angle = 0).

- Linear velocities variation

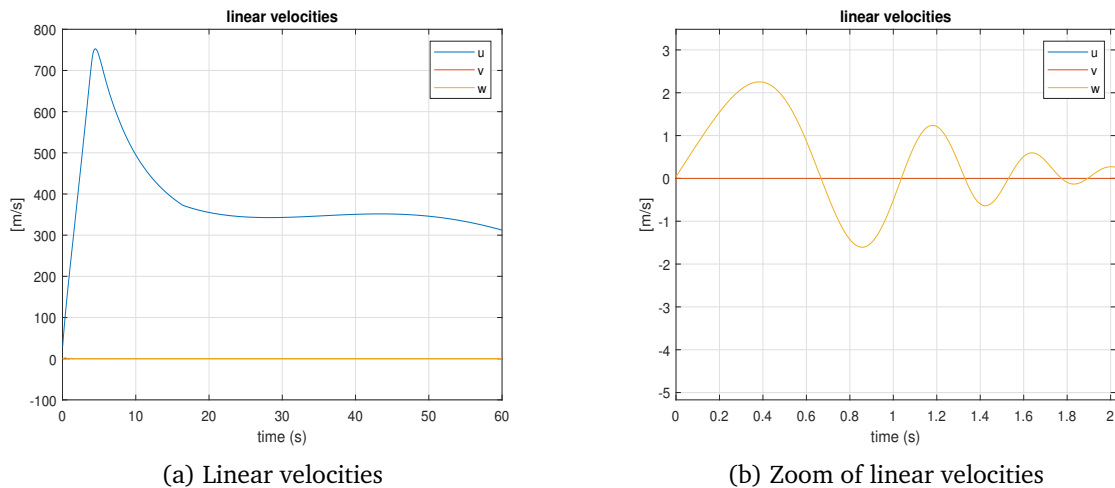

Figure 6.15: Evolution of Linear velocities.

Figure 6.15 shows the evolution of the linear velocities during the missile flight. It is clearly seen that the majority of speed is about the center-line axis of missile (x-axis), the speed about this axis increases linearly in the first 5 s until it gets its highest value ( $u = 750$  m/s at  $t = 5.6$  s). After this point the missile speed begins to decrease because of the termination of thrust, and continues to decrease until the end of simulation.

As it appears in figure 6.15(b), there is also a small variation on the pitch axis which can be neglected in front of the speed on the center-line axis.

- Angular velocities variation

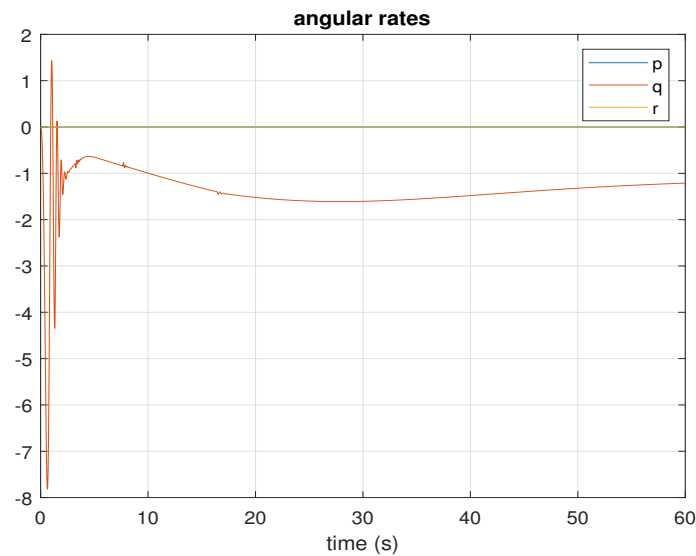

Figure 6.16: Angular velocities variation.

Figure 6.16 presents the evolution of the angular velocities during the time of simulation. It is clearly seen that the angular velocity about the two axes yaw and roll are zero because there is no moments about these two axes.

- Euler angles variation

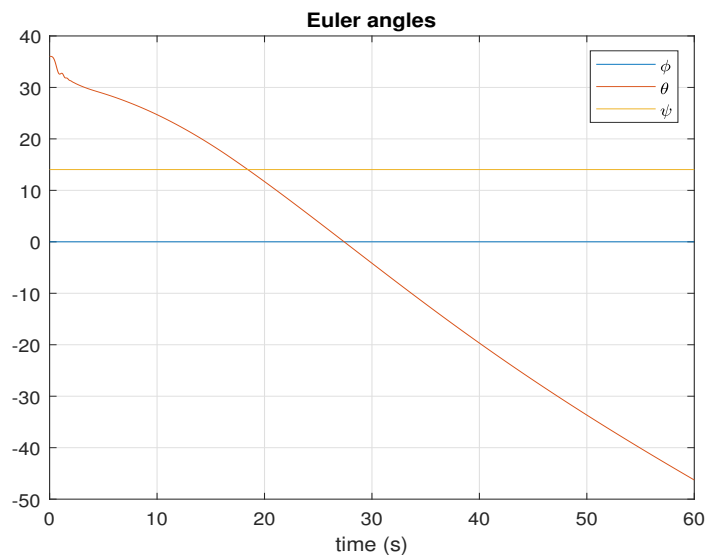

Figure 6.17: Euler angles variation.

Figure 6.17 shows the history of change of euler angles  $\psi$ ,  $\theta$  and  $\phi$  in heading, pitch and roll respectively. As we see, there is no change in roll angle ( $\phi = 0$ ) during the flight (nonrolling missile characteristics). The heading angle ( $\psi$ ) is constant on  $\psi = 15^\circ$  from the launch to the end of simulation. However, the pitch angle decreases rapidly in the first 5 s (from  $40^\circ$  to  $29^\circ$ ) because of the increasing in drag during the boost phase of flight, after this point the heading angle continues to decrease linearly until the end of simulation under the influence of gravity force acting on the missile.

- Missile trajectory

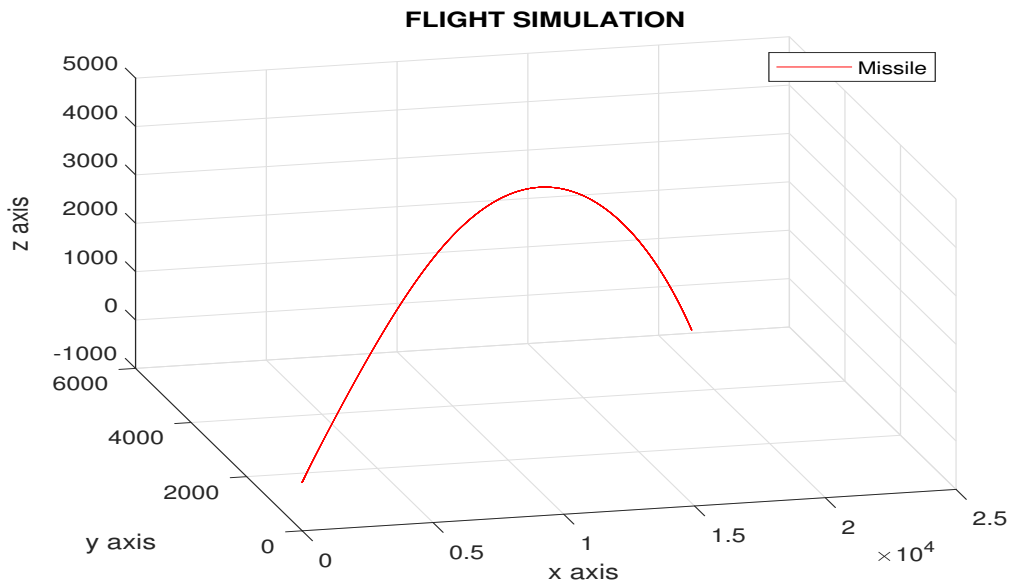

Figure 6.18: Missile trajectory.

Figure 6.18 illustrates the missile launch trajectory during its flight without acting on the deflection surfaces (the missile in this case is like a projectile).

## 6.4 Simulation results of missile-target 3D-engagement

In this section, we'll present all the simulation results obtained when applying the different guidance laws to guide the missile toward the target. We will restore the capacity of each method to keep track of the target in each maneuvers, straight and curved path with shortest time and lowest miss-distance.

In the coming results some parameters such as : thrust, mass, moment of inertia, center of mass, atmospheric parameters (temperature, pressure, air-density and speed of sound), gravity and Mach number are not presented because they are't affected by the use of guidance laws.

### 6.4.1 Target in straight flight with constant speed

In this simulation the target is flying at an altitude of 3 km and a speed of 250 m/s, and the target flight path is straight and offset laterally 1 km from the missile launch site. At the instant of missile launch the target is inbound at a downrange distance of 4 km from the launch site. The time of simulation is limited at 8 s, because we need 7.6 s at most to destruct the target.

The target position vector at a given time is calculated by using:

$$P_T = P_{T0} + V_T t, \quad m \quad (6.4)$$

6.4.1.1 Proportional Navigation results

- Inputs variation

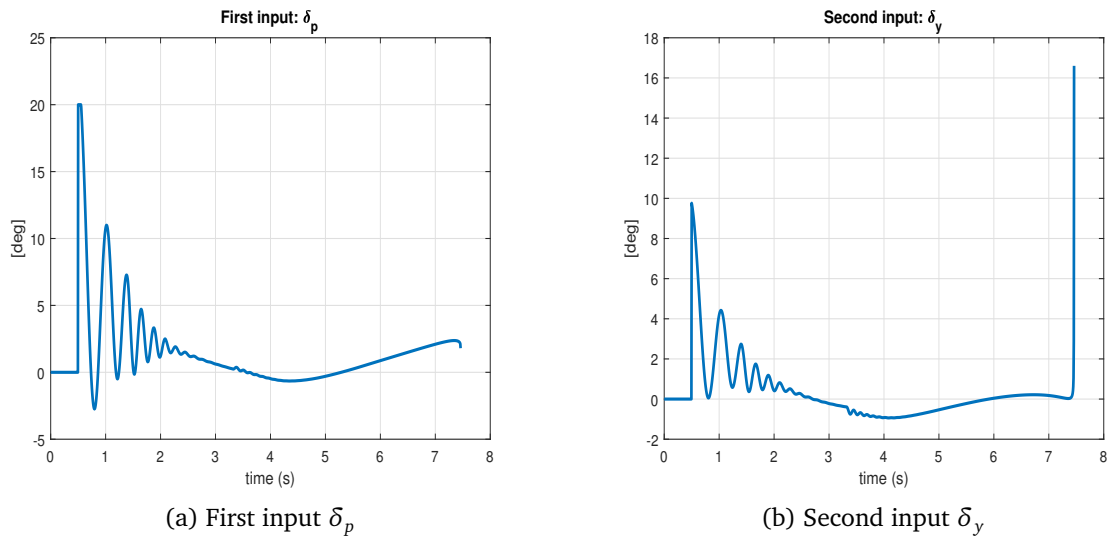

Figure 6.19: First and second inputs variation

Figure 6.19 illustrates the variation in deflection surfaces during the flight. As we see, guidance is not initiated until a short time called "time to go  $t_{go}$ " after launch in order to permit the missile to gain enough speed so that it can be controlled. After this point the autopilot bases the missile maneuver commands on the achieved seeker-head angular rate vector, and the control system responds to autopilot commands by deflecting the control surfaces. In the early time of flight the fins are deflected violently because the seeker seeks to track the line of sight, once he got it the deflections will be smooth as possible.

- Lift and Drag forces variation

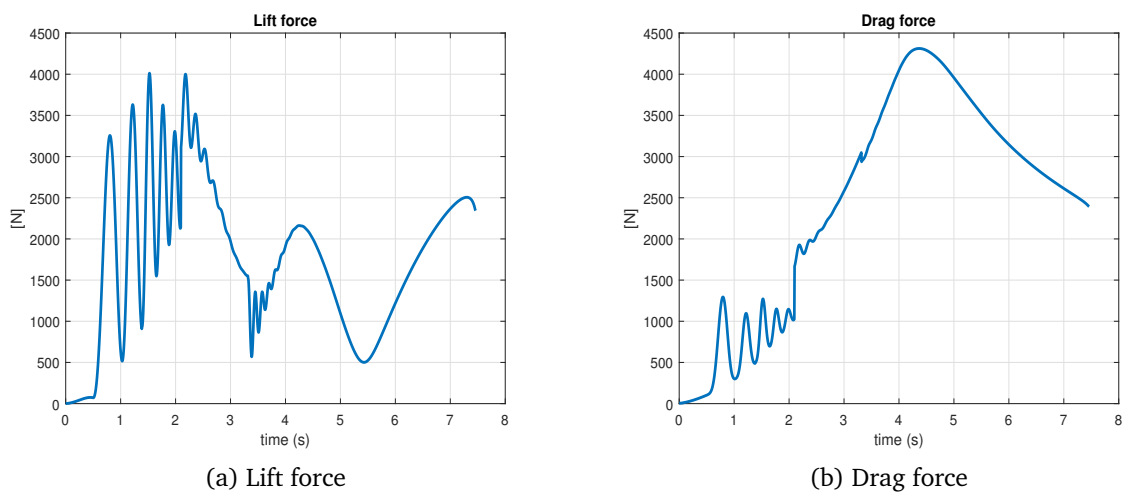

Figure 6.20: Lift and Drag forces variations.

- Angle of attack and Side-slip angle variation

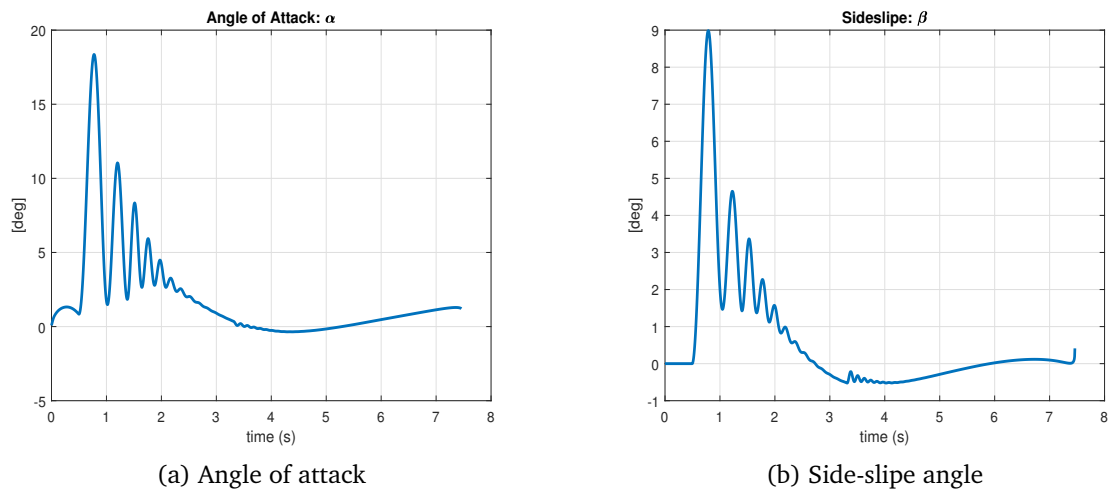

Figure 6.21: Angle of attack and Side-slip angle histories.

The angle of attack and sideslip angle histories that result from the moments applied to the missile are shown in Figure 6.21. During the half second before guidance is initiated, the angle of attack begins to increase slightly because gravity causes the missile flight path to deviate downward from the direction the missile is initially pointed as it leaves the launcher. The restoring moment, caused by this small angle of attack, rotates the missile downward to point into its relative wind; this reduces the angle of attack essentially to zero by the time guidance is initiated and the missile begins to track the desired angles and tries to remain there.

- Total angle of attack variation

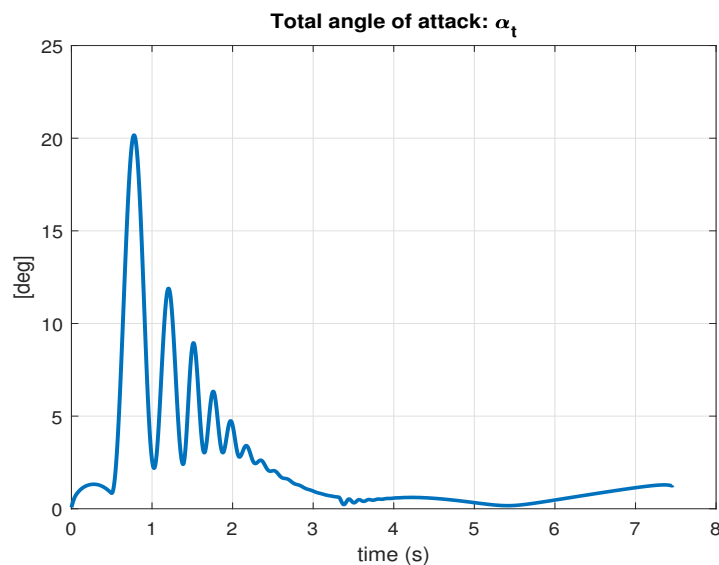

Figure 6.22: Total angle of attack variation.

• Pitch and Yaw moments variation

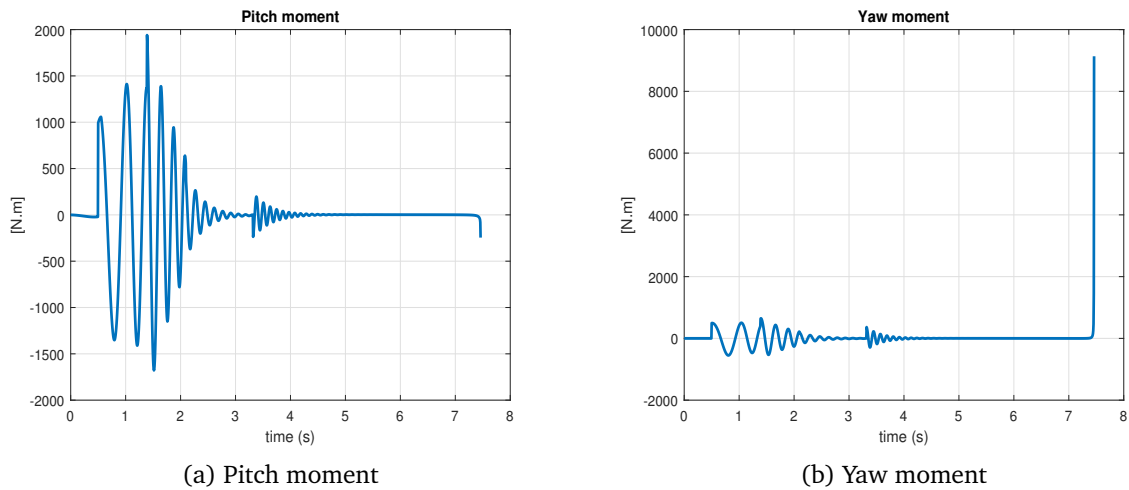

Figure 6.23: Pitch and Yaw moments variation.

The pitch and yaw rotational moments on the missile caused by the combination of fin deflections, the restoring moment from the resulting angle of attack, and the damping effect of the missile angular rate are shown in Figure 6.23. When the control fins are initially deflected a large moment is generated and the missile rotates and overshoots the trim angle of attack. A restoring moment is generated to rotate the missile back toward the trim condition; this results in an oscillatory motion. The damping moment causes the oscillations to diminish until trim conditions are achieved.

• Linear velocities variation

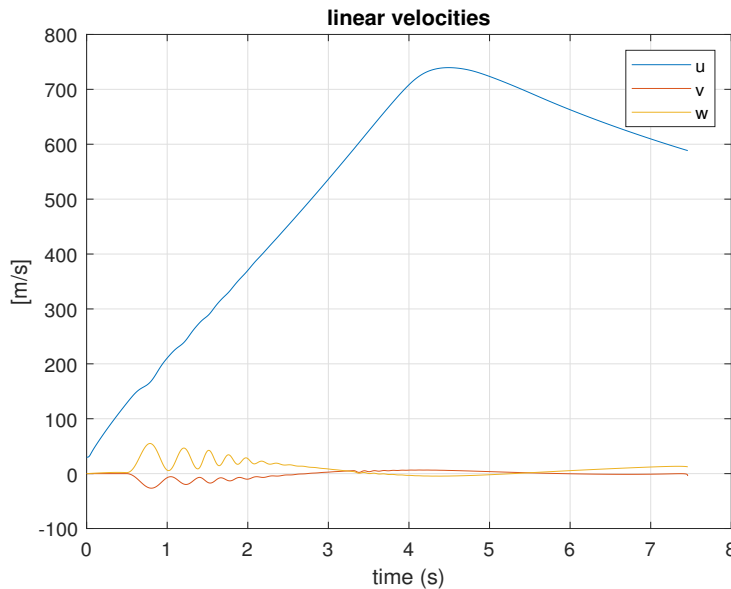

Figure 6.24: Evolution of Linear velocities.

Figure 6.24 illustrates the evolution of missile linear velocities about the three axes pitch, yaw and roll respectively. The majority of missile speed is about the center line axis (the one in blue), which increases linearly in the first 4 seconds until its highest value ( $u = 750 \text{ m/s}$  at  $t = 4.45 \text{ s}$ ), the flight perturbation of the speed during the first 2 s is caused by the increased drag

that results from the missile maneuvers. After this point the speed decreases linearly until the interception with target.

There is also some variation in speed about y and z axes which oscillates in the first 3 s after  $t_{go} = 0.5s$ , caused by the oscillation in the inputs.

- **Angular velocities variation**

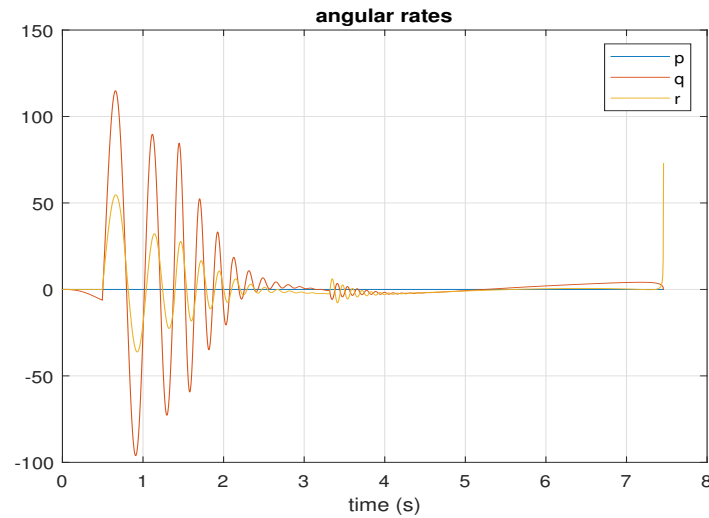

Figure 6.25: Angular velocities variation.

Figure 6.25 shows the variation of the angular rates  $p$ ,  $q$  and  $r$  of roll, pitch and yaw respectively. During the first half second, we remark small decreasing in the pitch angular rate ( $q$ ) results of the gravity effect. After this point, the two angular rates of pitch and yaw ( $q$  and  $r$  respectively) begin to oscillate as a result of pitching and yawing moments in order to guide the missile toward the target.

- **Euler angles variation**

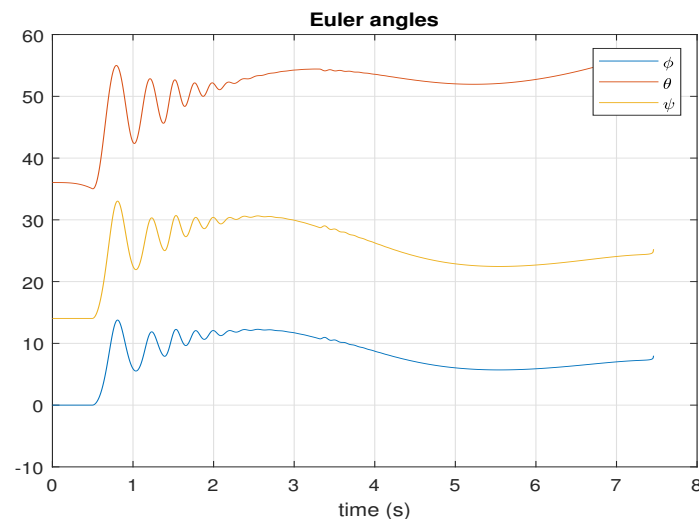

Figure 6.26: Euler angles variation.

Figure 6.26 illustrates the behavior of the euler angles  $\psi$ ,  $\theta$  and  $\phi$  in heading, pitch and roll respectively, during the missile flight. As the missile change its orientation in space toward the target, the euler angles rates change.

- Missile and Target trajectories

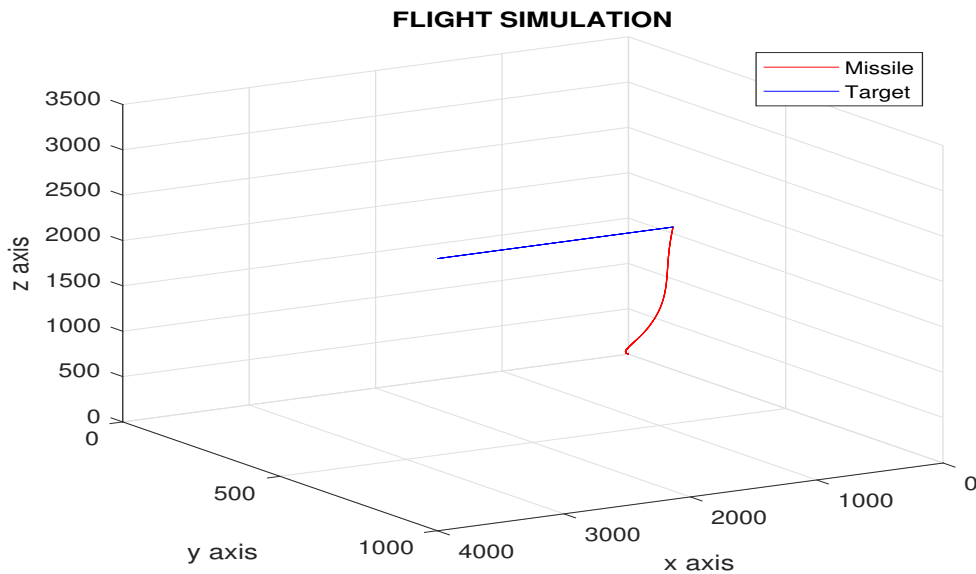

Figure 6.27: Missile and Target engagement in 3 dimensions.

```

Miss_distance =

    0.0040

Time_of_closest_approach =

    7.4587

*****
*----- THE TARGET HAS BEEN DESTROYED -----*
*----- GAME OVER -----*
*****

```

Figure 6.27 shows the missile and target trajectories during the flight, and their interception point in 3D. As we see in this figure the launcher is aimed directly at the target at the time of launch, the proportional navigation guidance causes the missile to turn in a direction to lead the target as is required to strike a moving target. This missile maneuver is initiated when guidance is turned on (0.5 s). At this early time in the flight, the missile speed is slow, which causes the amount of lead, and, therefore, the amount of the maneuver to be overestimated. As the missile gains speed, the missile flight path is corrected until intercept with target at  $t = 7.4587$  s with miss-distance = 0.004 m as we see in the simulation result.



## 6.4.1.2 Beam Rider or Command to line of sight results

- Inputs variation

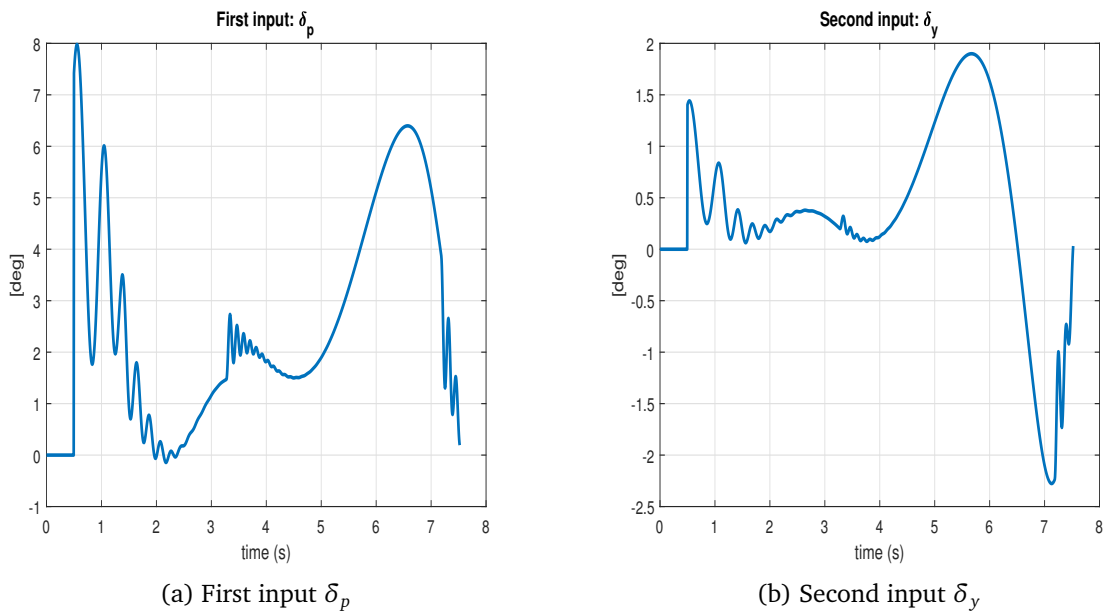

Figure 6.28: First and second inputs variation.

- Lift and Drag forces variation

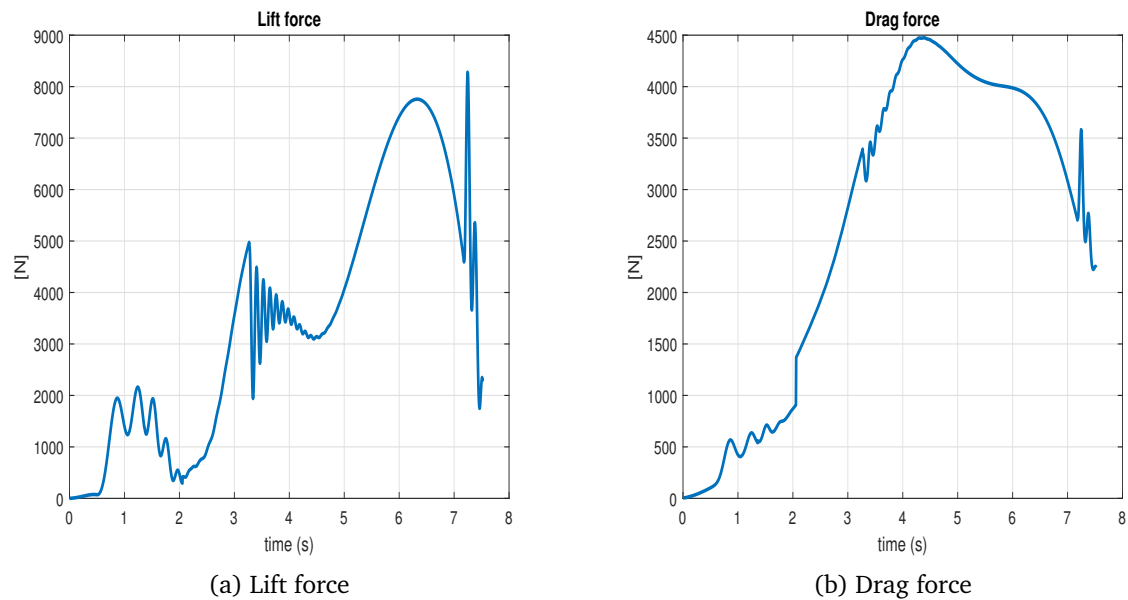

Figure 6.29: Lift and Drag forces variations.

- Angle of attack and Side-slip angle variation

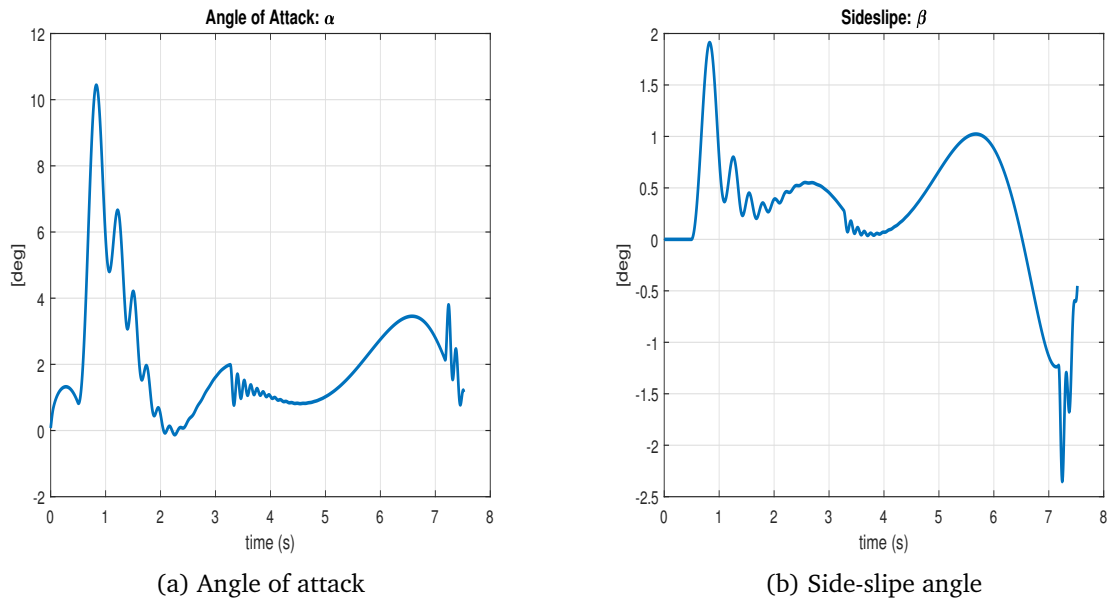

Figure 6.30: Angle of attack and Side-slip angle variation.

- Total angle of attack variation

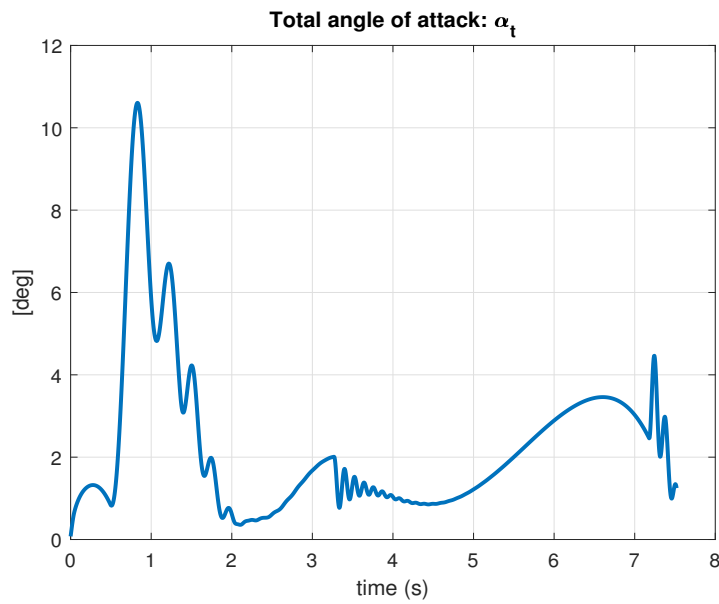

Figure 6.31: Total angle of attack variation.

- Pitch and Yaw moments variation

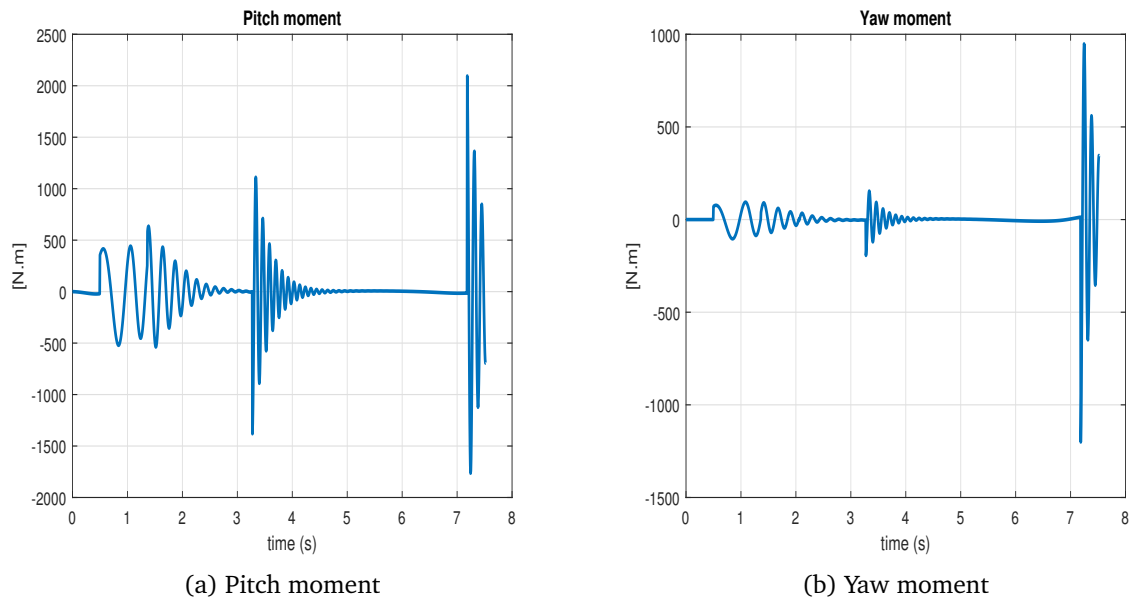

Figure 6.32: Pitch and Yaw moments variation.

- Linear velocities variation

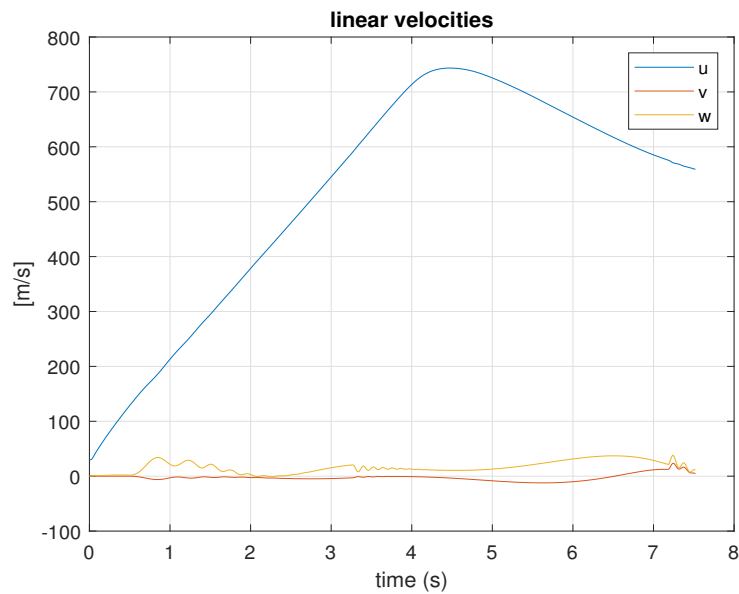

Figure 6.33: Evolution of Linear velocities .

- Angular velocities variation

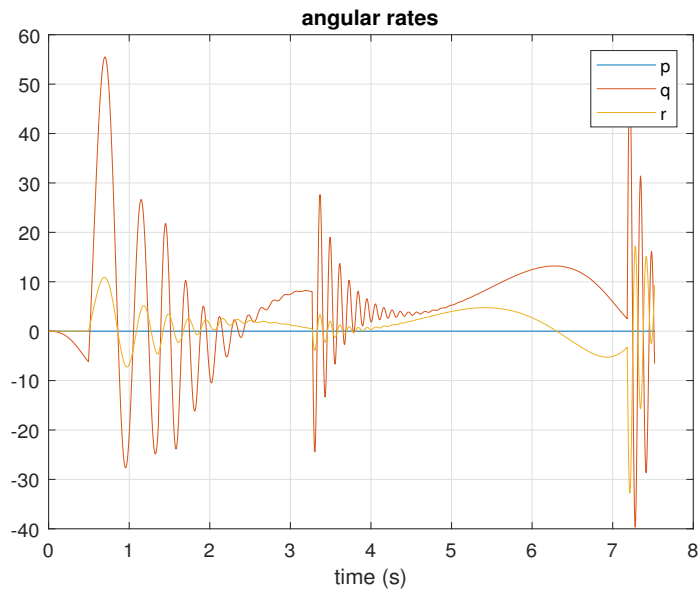

Figure 6.34: Angular velocities variation.

- Euler angles variation

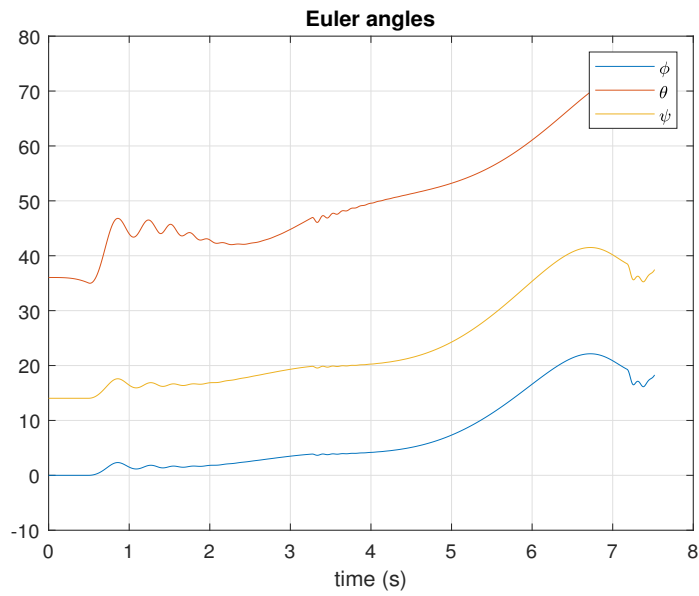

Figure 6.35: Euler angles variation.

- Missile and Target trajectories

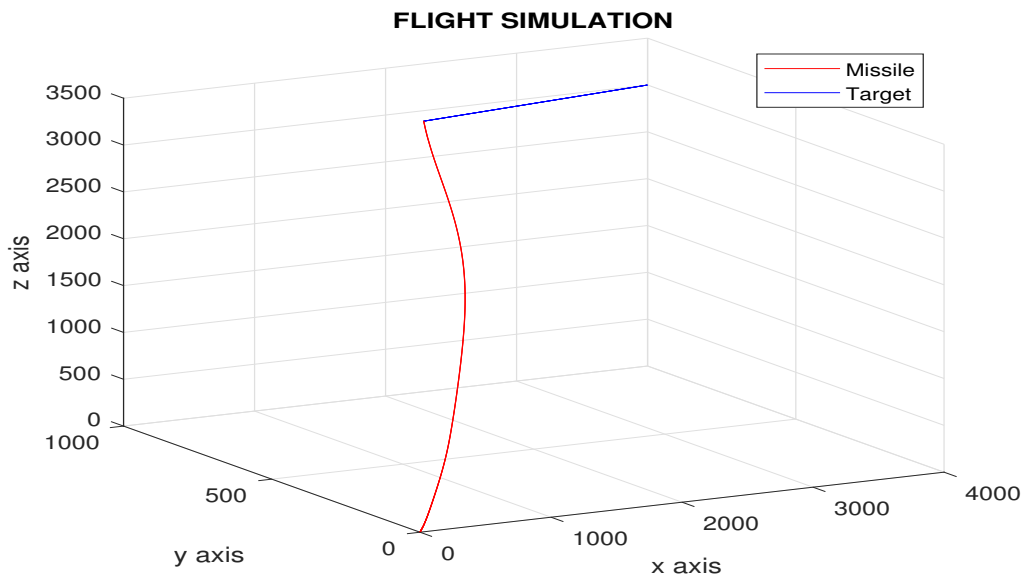

Figure 6.36: Missile and Target engagement in 3 dimensions.

```

Miss_distance =

    0.4655

Time_of_closest_approach =

    7.5197

*****
*----- THE TARGET HAS BEEN DESTROYED -----*
*----- GAME OVER -----*
*****

```

#### Discussion:

Figures from 6.28 to 6.36 show the variation of different parameters during the missile engagement when Beam Rider or CLOS guidance used. The dynamics seems to be the same, in other words there isn't a remarkable difference between the three guidance laws in terms of the dynamics.

Figure 6.32 illustrates the variation of the pitch and yaw rotational moments caused by the difference of pressure applied on the control surfaces, this figure show some chattering which can be minimized by the damping effect of the missile.

Figure 6.33 shows the evolution of the linear velocities during the flight. It can be seen that the majority of speed is about the center-line axis (the blue one "u"), some variation on pitch and yaw axes is marked also.

The angular rates show some oscillations and chattering caused by the rotational moments applied about the pitch and yaw axes as shown in the figure 6.34.

From the flight path figure (figure 6.36) we can see that the center-line axis of missile is directed toward the target at each instant during the flight until the interception point (or at closet

approach), where the miss-distance = 0.4655 m at  $t = 7.5197$  s. This is the geometry of the Beam rider guidance where the missile's centerline is always pointing toward the target.

### 6.4.1.3 PD based guidance results

- Inputs variation

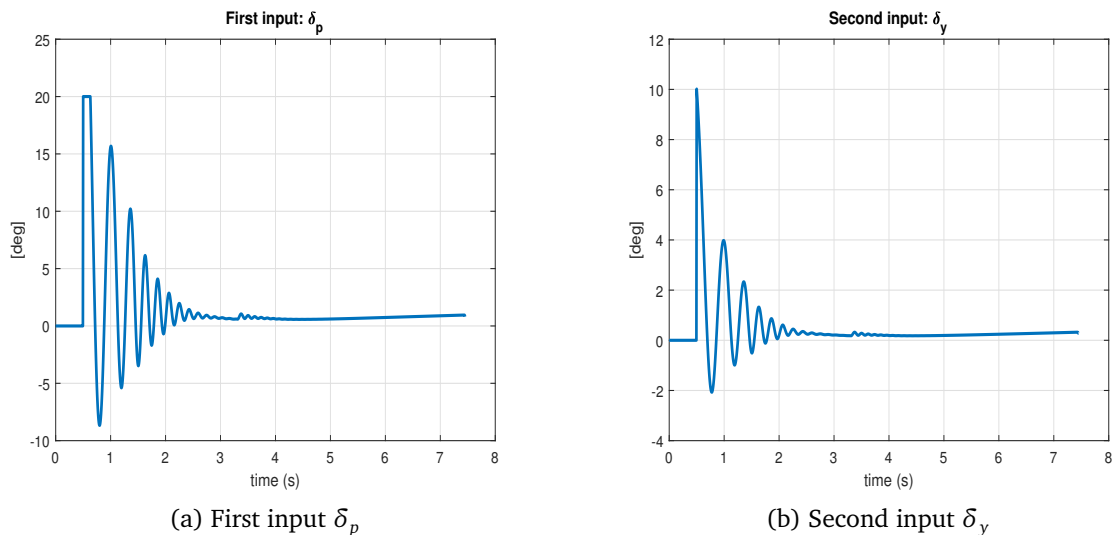

Figure 6.37: First and second inputs variation.

- Lift and Drag forces variation

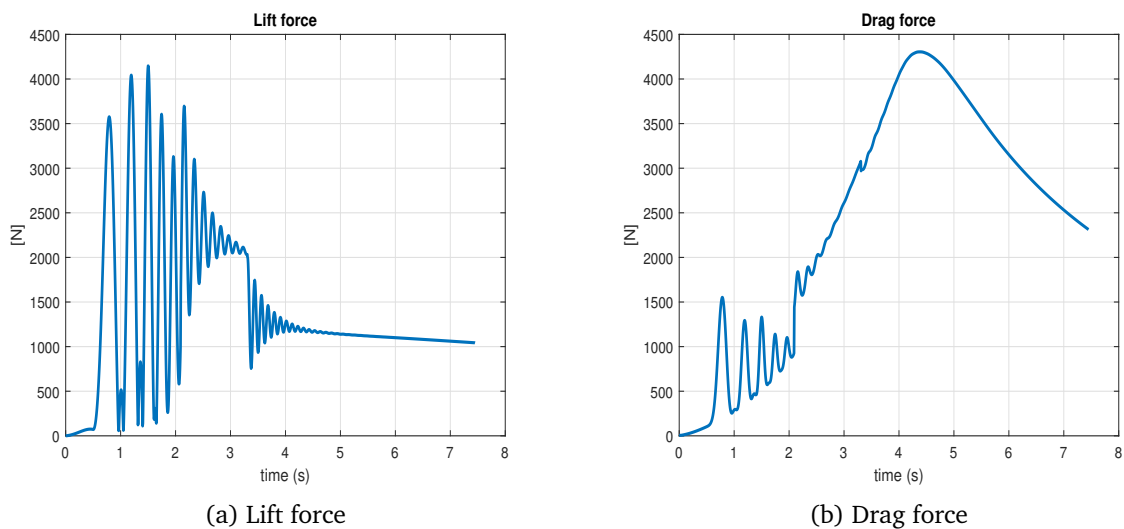

Figure 6.38: Lift and Drag forces variations.

- Angle of attack and Side-slip angle variation

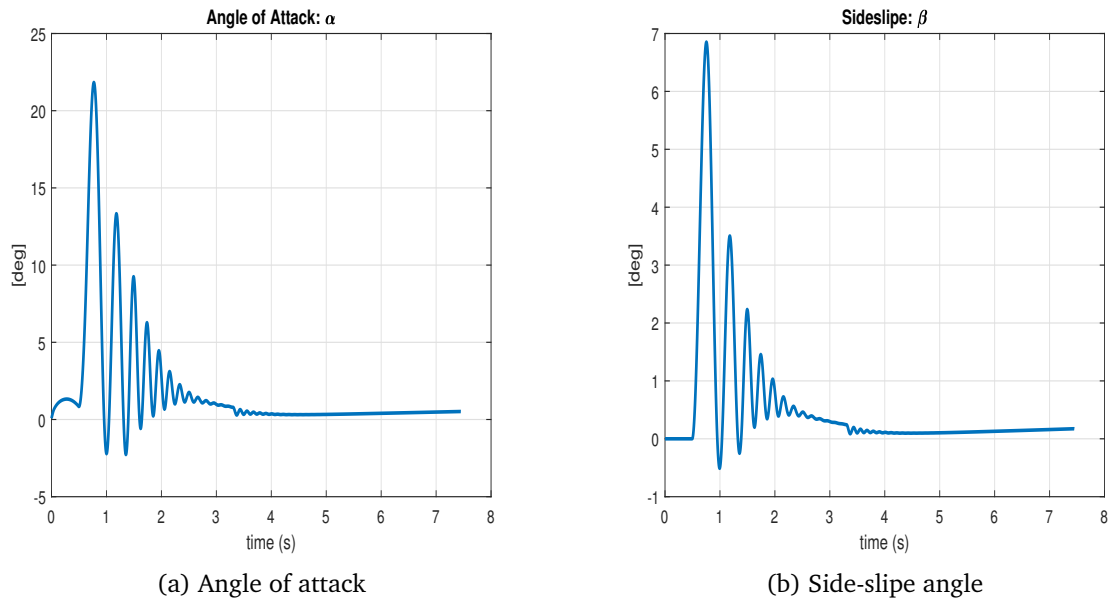

Figure 6.39: Angle of attack and Side-slip angle variation.

- Total angle of attack variation

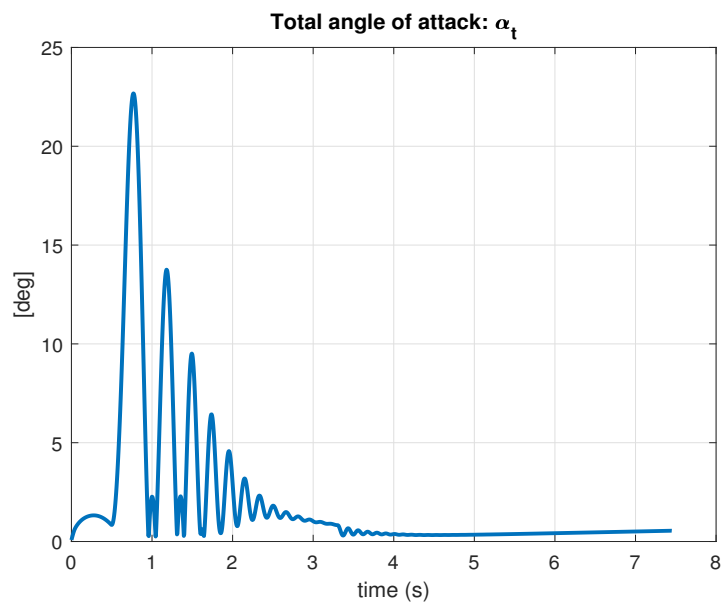

Figure 6.40: Total angle of attack variation

• Pitch and Yaw moments variation

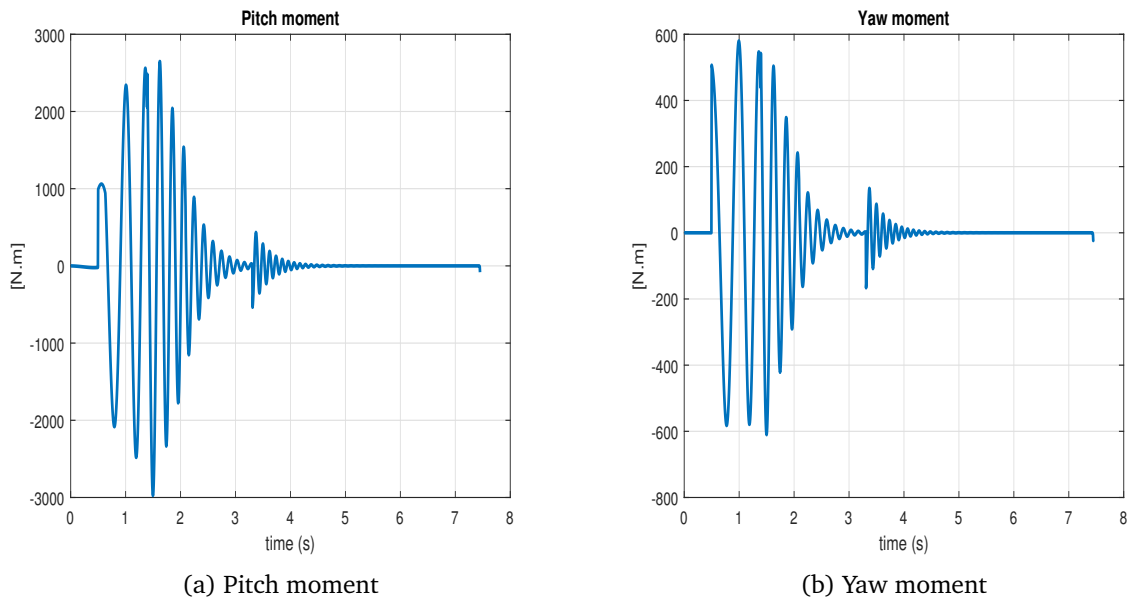

Figure 6.41: Pitch and Yaw moments variation

• Linear velocities variation

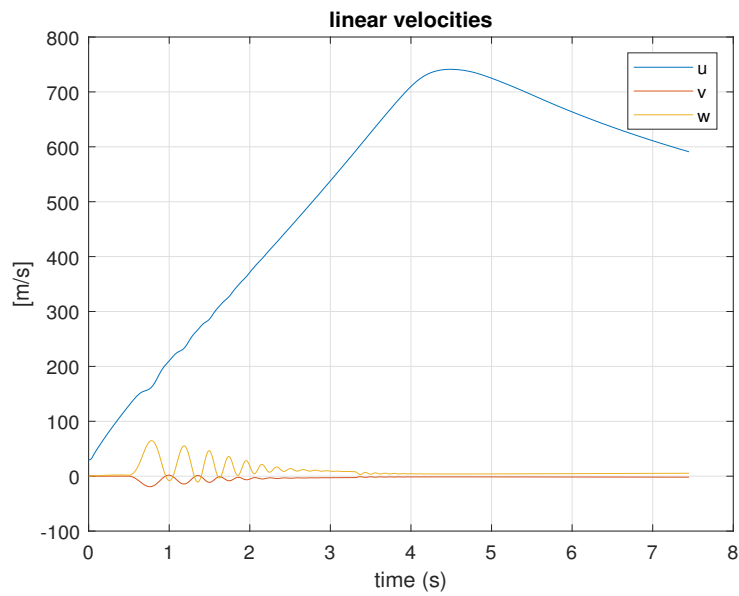

Figure 6.42: Evolution of Linear velocities .



- Angular velocities variation

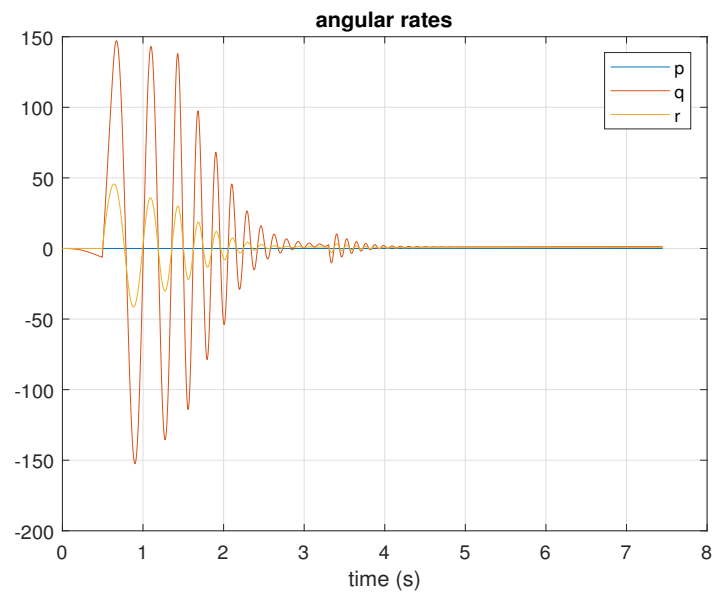

Figure 6.43: Angular velocities variation.

- Euler angles variation

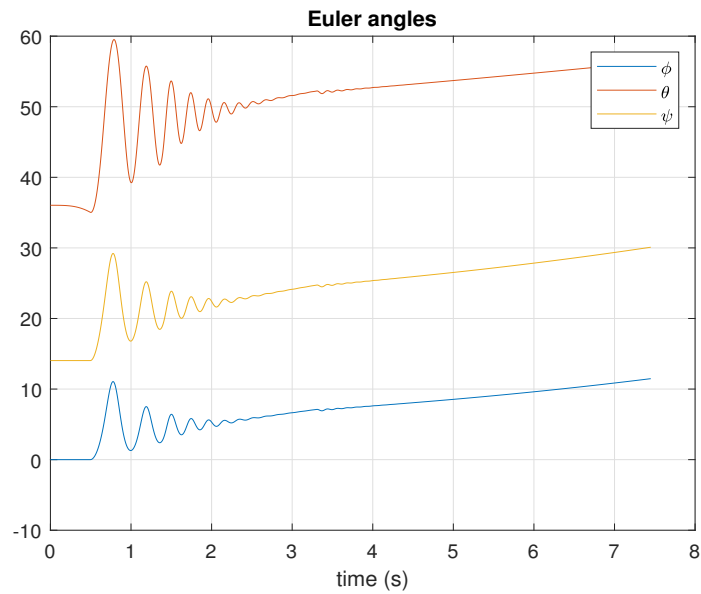

Figure 6.44: Euler angles variation.

- Missile and Target trajectories

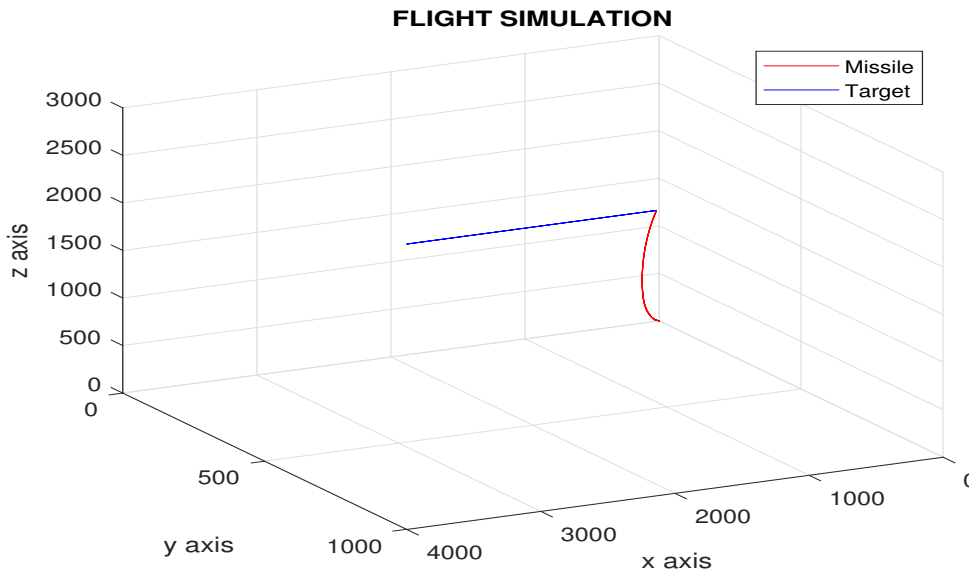

Figure 6.45: Missile and Target engagement in 3 dimensions.

```

Miss_distance =
    1.0492

Time_of_closest_approach =
    7.4508

*****
*----- THE TARGET HAS BEEN DESTROYED -----*
*----- GAME OVER -----*
*****
    
```

**Discussion:**

Through the above simulation figures, we have illustrated the effect of this command on the evolution of each parameter during the time of simulation. This method is easily implemented and the desired tracking performance can be obtained by suitably selecting the controller gains using **PSO algorithm**.

The use of the sign function in the lateral acceleration equation ( see ( 5.29 )) served to minimize oscillations

Figure 6.45 shows the two paths of missile and target, and their interception point at  $t = 7.4508$  s with miss-distance = 1.0492 m.

**6.4.2 Target in a weaving flight**

In this case the target is flying at an altitude of 3 km. The target flight path is curved and offset laterally 1 km from the missile launch site. At the instant of missile launch the target is inbound at a downrange distance of 4 km from the launch site.

The weaving flight path can be modeled by calculating the maneuver acceleration as a function of time by using:

$$A_T = \omega_T \times V_T(t - \Delta t) \quad (6.5)$$

where

$\omega_T$  = the angular rate vector of the target flight path, rad/s

$V_T(t - \Delta t)$  = the previous target speed.

The velocity vector  $V_T(t)$  is given by:

$$V_T(t) = V_T(t - \Delta t) + A_T \Delta t \quad (6.6)$$

then the target position vector is obtained by using:

$$P_T(t) = P_T(t - \Delta t) + V_T(t - \Delta t) \Delta t + \frac{A_T \Delta t^2}{2} \quad (6.7)$$

### 6.4.2.1 Proportional Navigation results

- Inputs variation

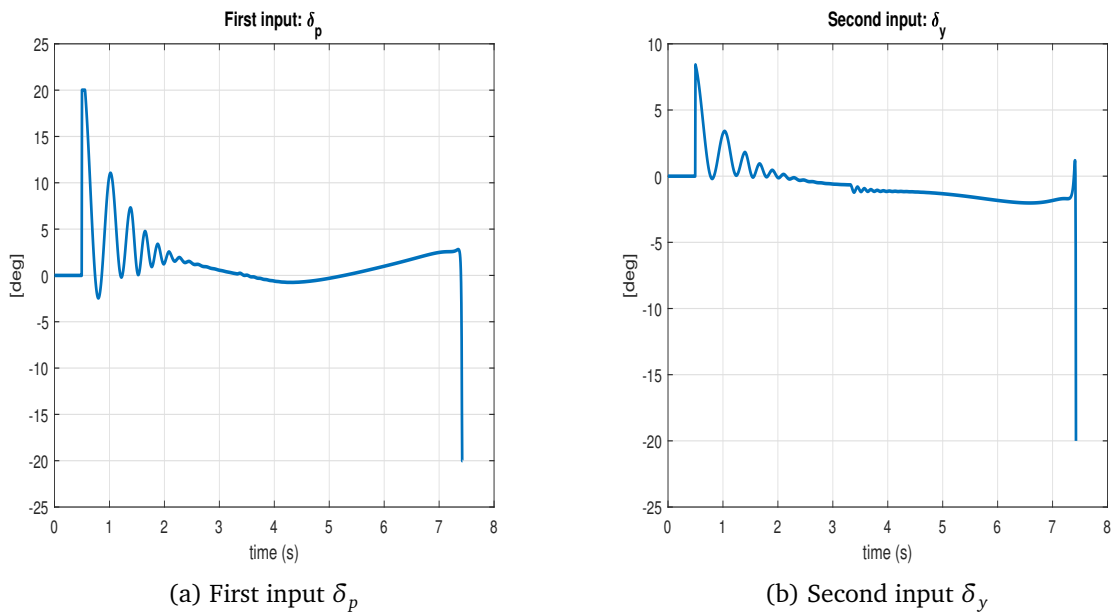

Figure 6.46: First and second inputs variation.

- Lift and Drag forces variation

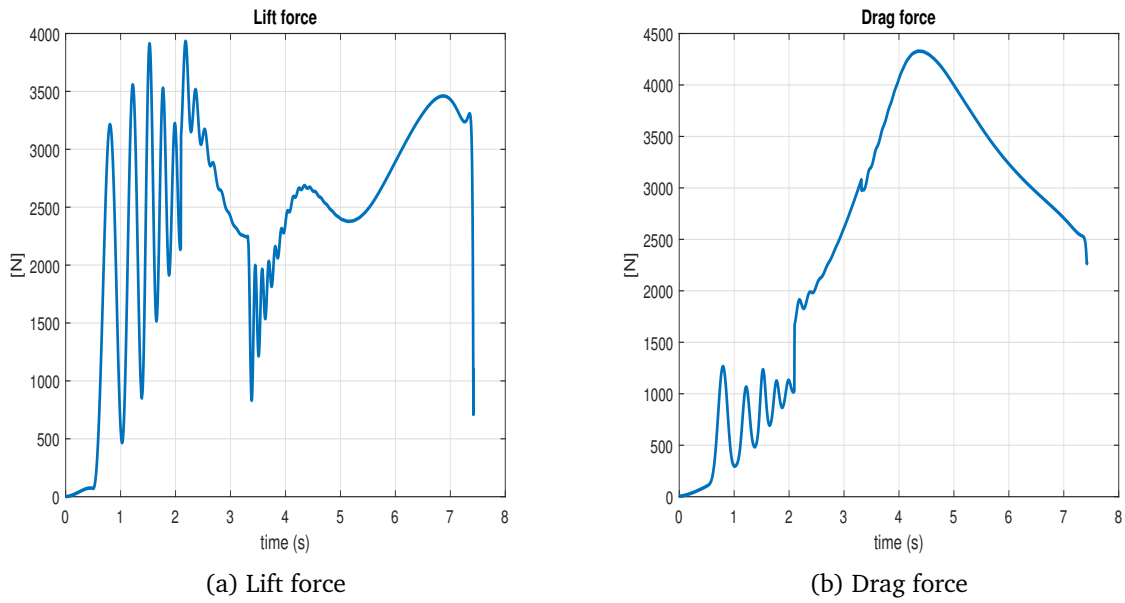

Figure 6.47: Lift and Drag forces variations.

- Angle of attack and Side-slip angle variation

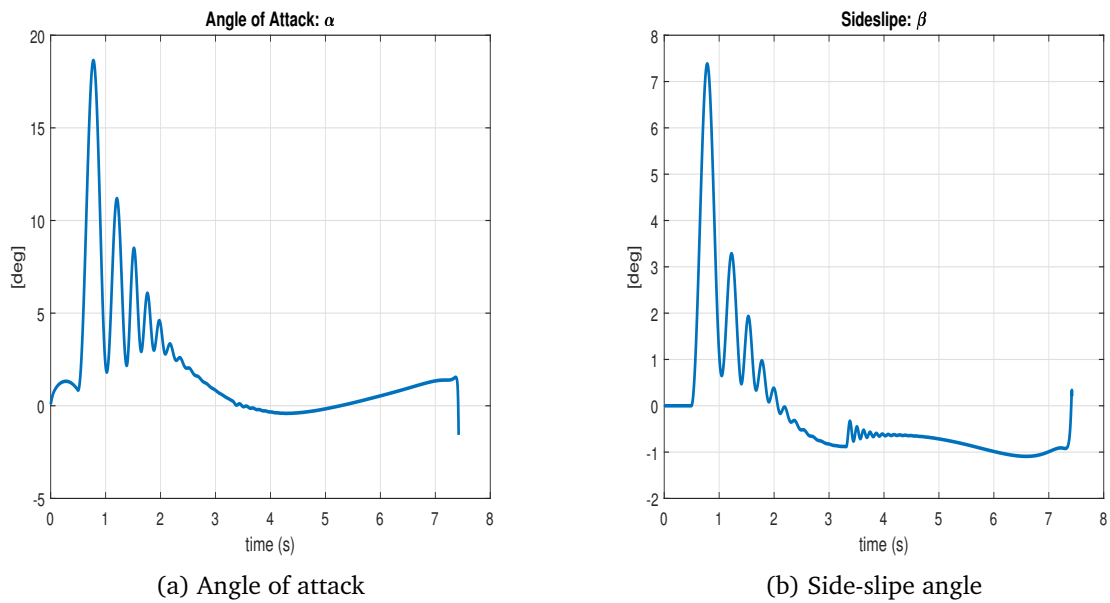

Figure 6.48: Angle of attack and Side-slip angle variation.

- Total angle of attack variation

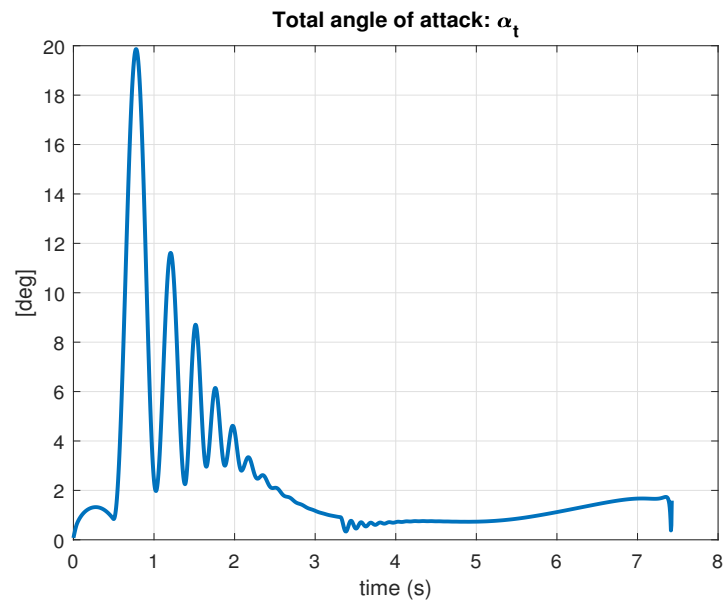

Figure 6.49: Total angle of attack variation.

- Pitch and Yaw moments variation

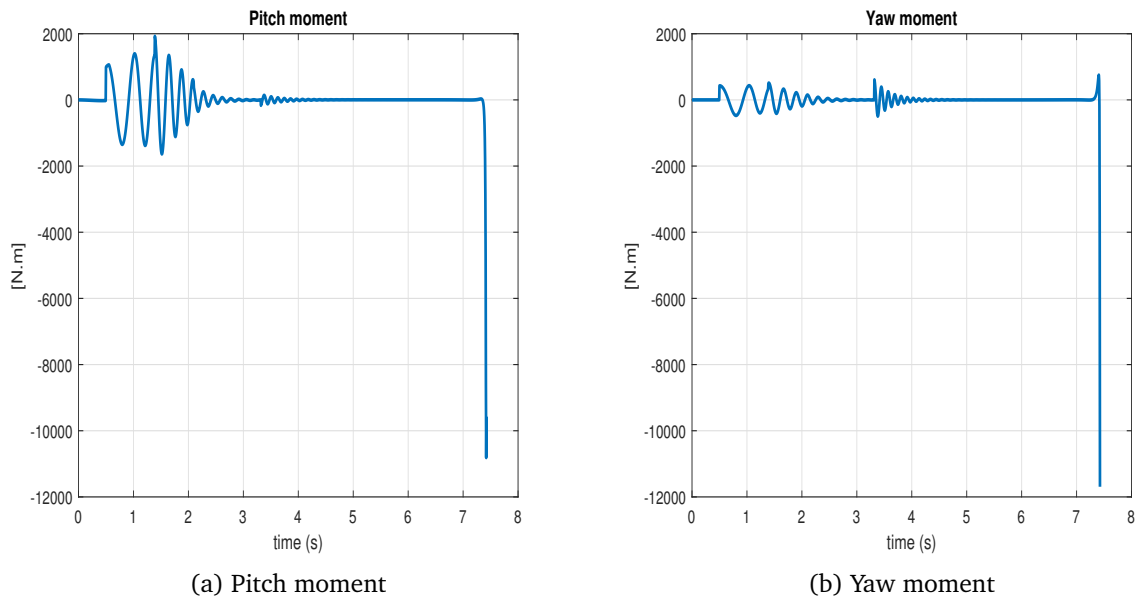

Figure 6.50: Pitch and Yaw moments variation.

- **Linear velocities variation**

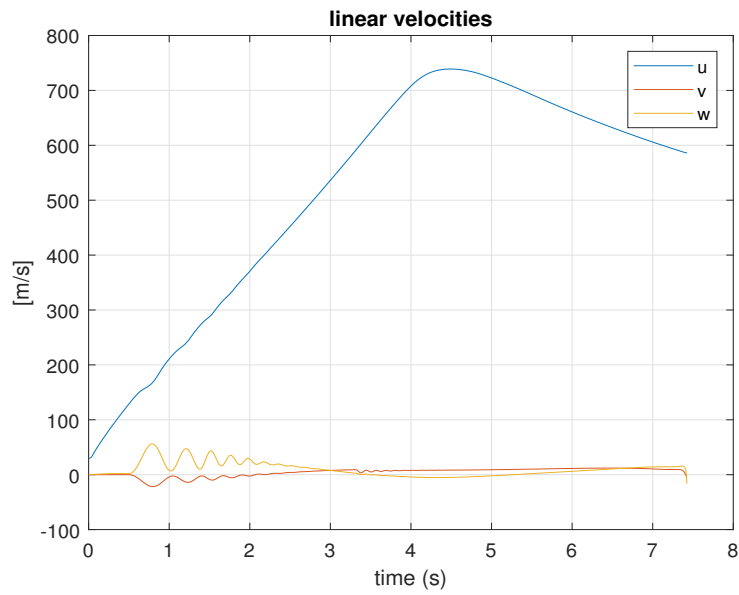

Figure 6.51: Evolution of Linear velocities .

- **Angular velocities variation**

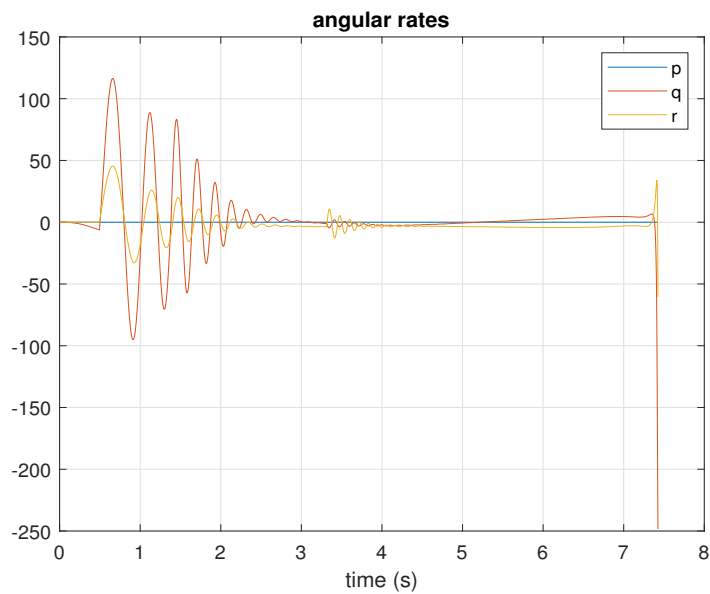

Figure 6.52: Angular velocities variation.

- Euler angles variation

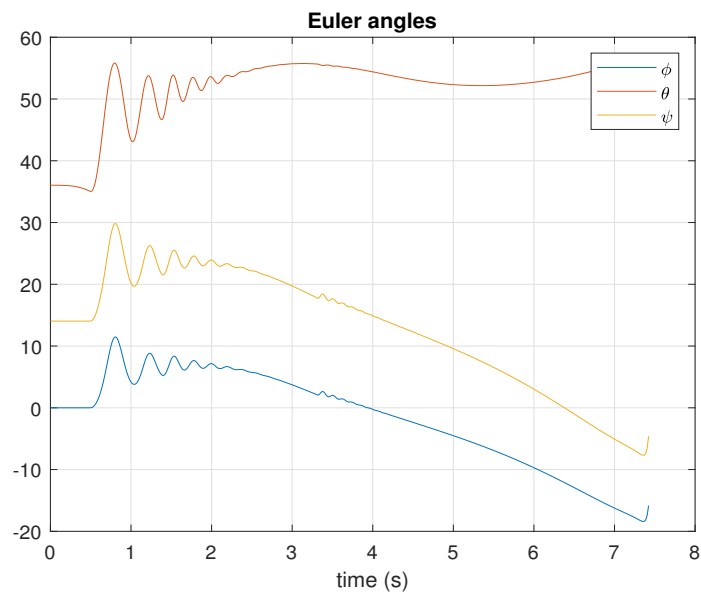

Figure 6.53: Euler angles variation.

- Missile and Target trajectories

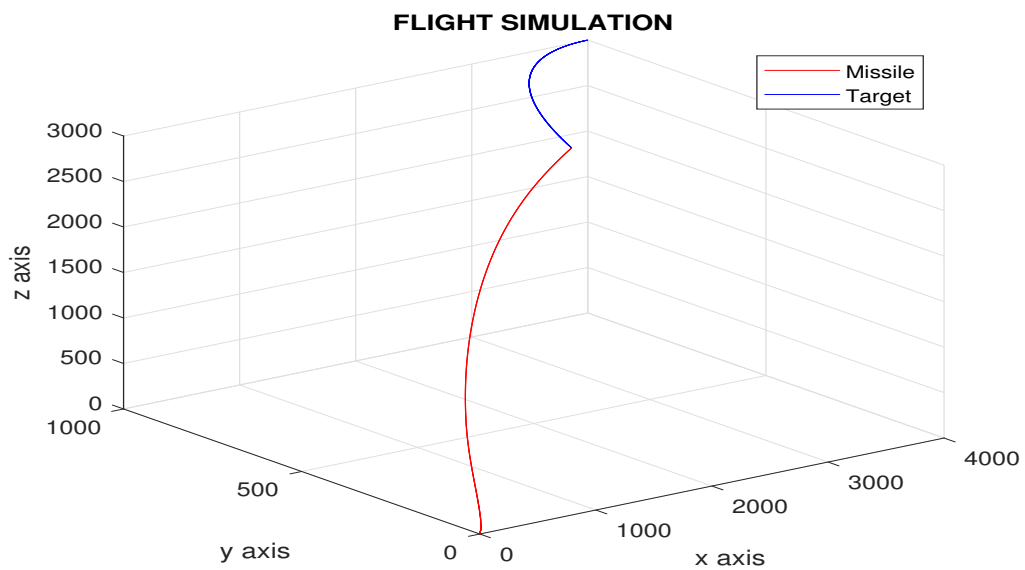

Figure 6.54: Missile and Target interception.

```

Miss_distance =

    0.1612

Time_of_closest_approach =

    7.4275

*****
*----- THE TARGET HAS BEEN DESTROYED -----*
*----- GAME OVER -----*
*****
    
```

**Discussion:**

Figures from 6.46 to 6.54 show the variation of different parameters during the missile engagement when PN used. The 3D plot in figure 6.54 shows clearly the geometry of PN which is the constant bearing angle kept between the LOS and the missile centerline.

**6.4.2.2 Beam Rider or Command to line of sight results**

- **Inputs variation**

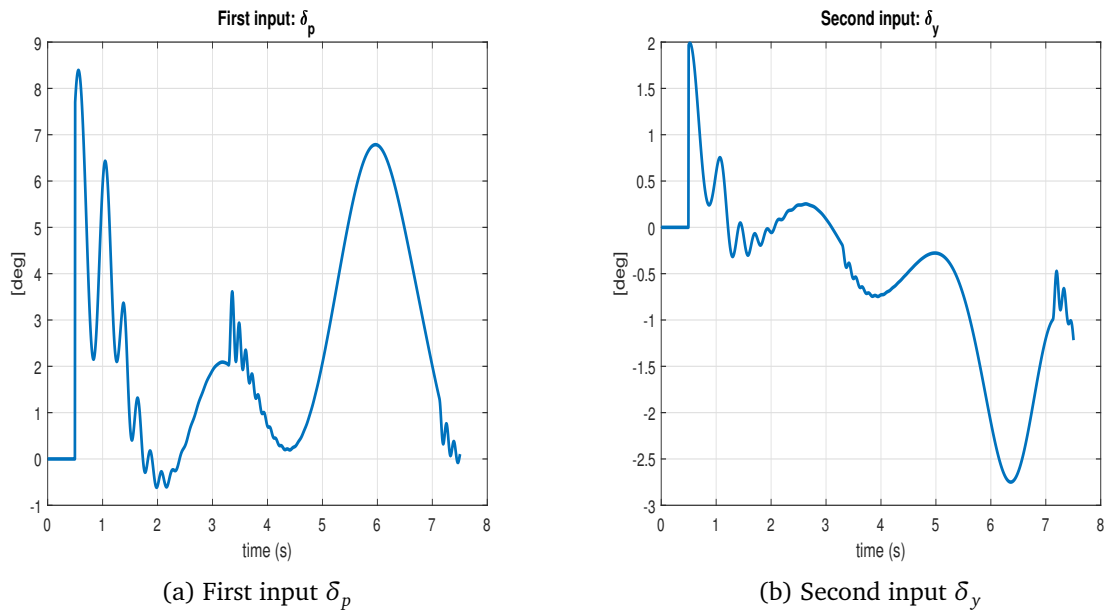

Figure 6.55: First and second inputs variation.



- Lift and Drag forces variation

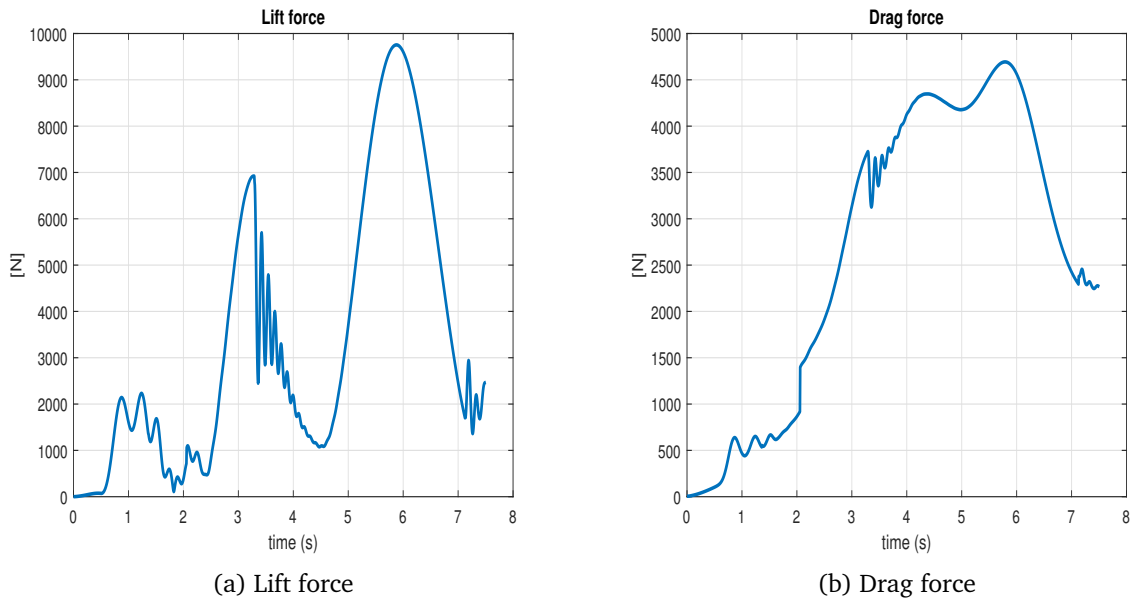

Figure 6.56: Lift and Drag forces variations.

- Angle of attack and Side-slip angle variation

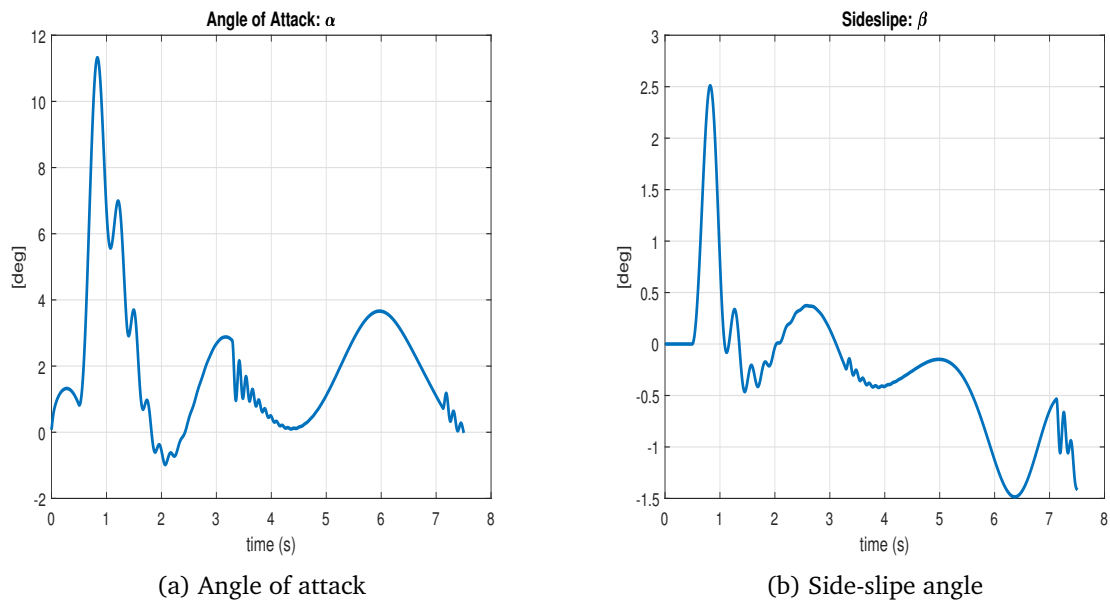

Figure 6.57: Angle of attack and Side-slip angle variation.

- Total angle of attack variation

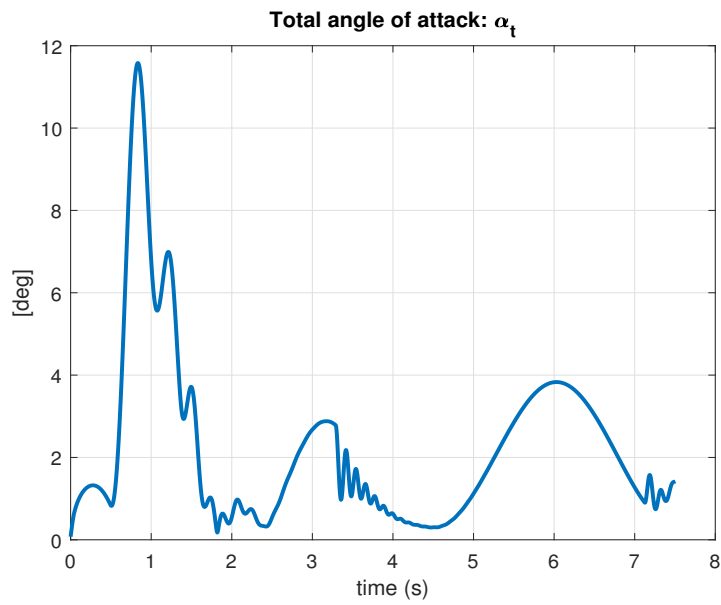

Figure 6.58: Total angle of attack variation.

- Pitch and Yaw moments variation

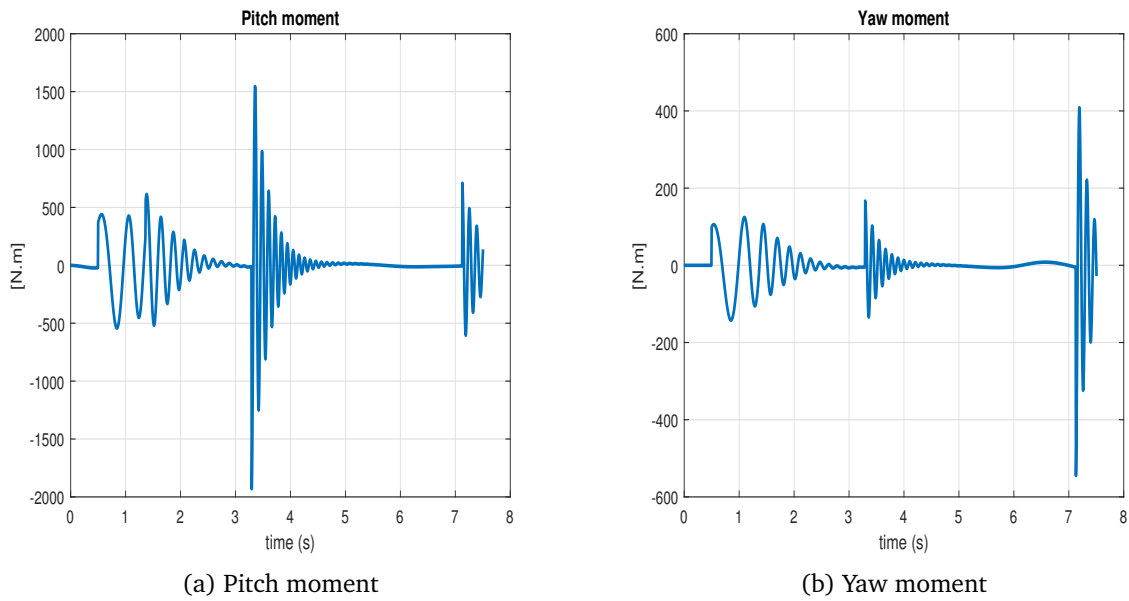

Figure 6.59: Pitch and Yaw moments variation.

- Linear velocities variation

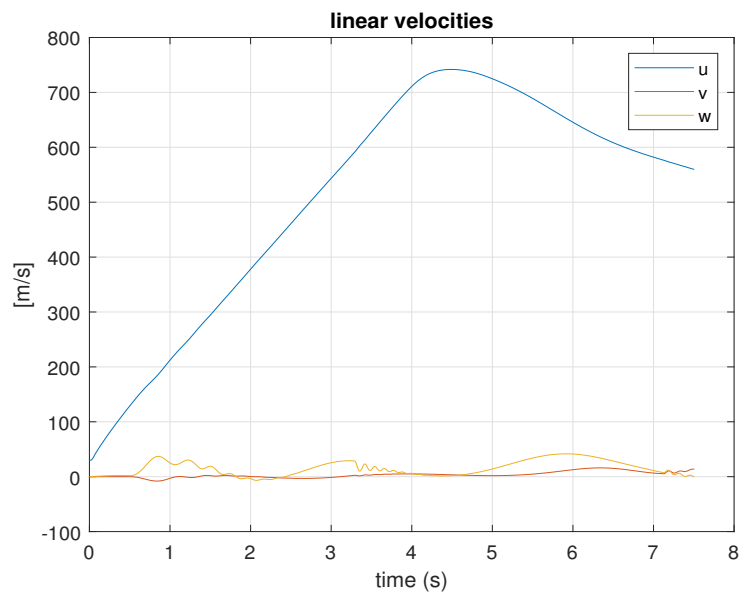

Figure 6.60: Evolution of Linear velocities.

- Angular velocities variation

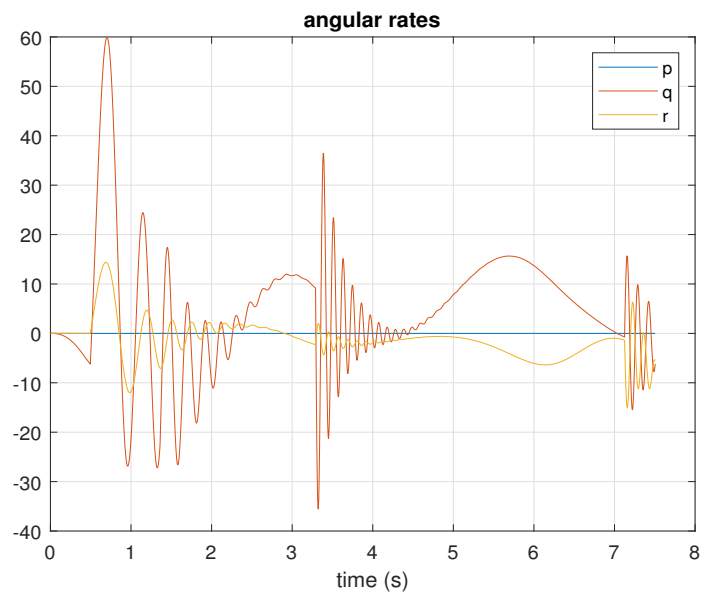

Figure 6.61: Angular velocities variation.

- Euler angles variation

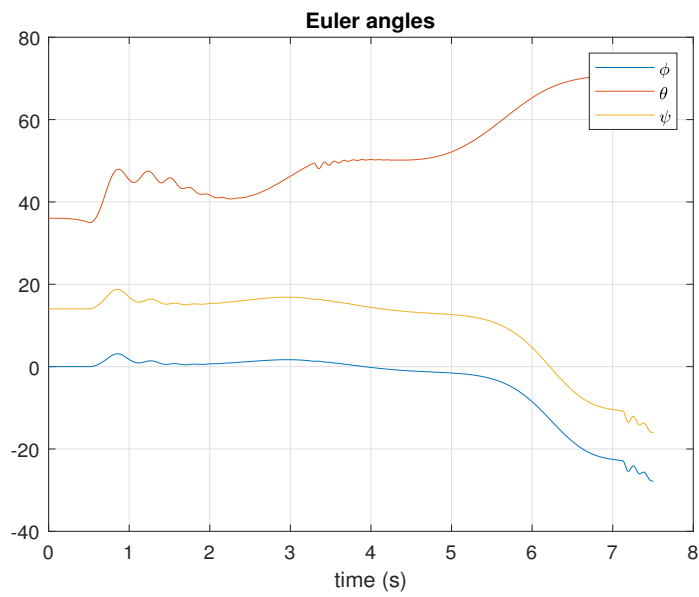

Figure 6.62: Euler angles variation.

- Missile and Target engagement in 3 dimensions.

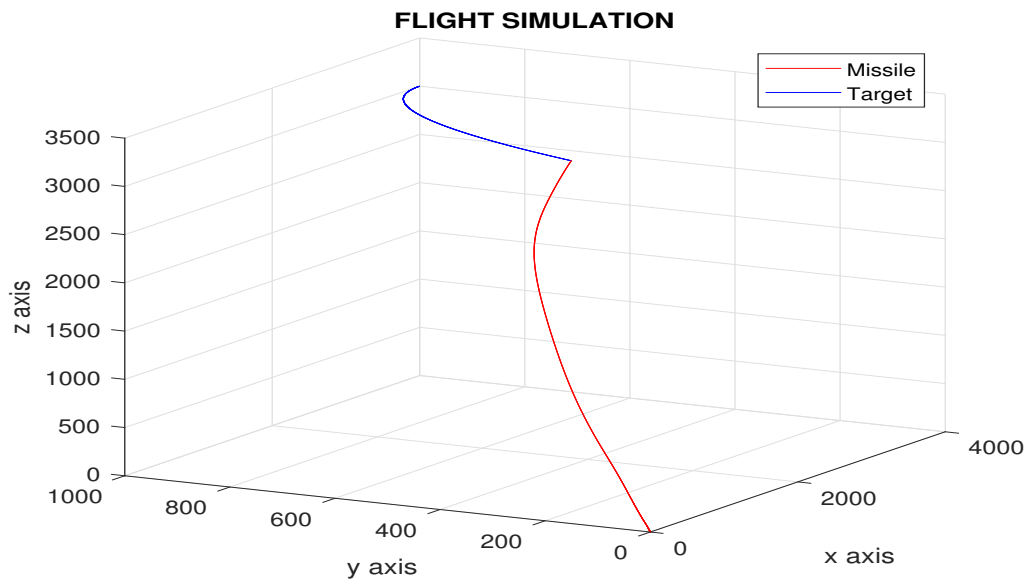

Figure 6.63: Missile and Target engagement in 3 dimensions.

```

Miss_distance =

    0.4597

Time_of_closest_approach =

    7.5070

*****
*----- THE TARGET HAS BEEN DESTROYED -----*
*----- GAME OVER -----*
*****

```

### Discussion:

Figures from 6.5 to 6.63 show the variation of different parameters during the missile engagement when LOS guidance applied. The figure 6.55 shows that the control signal was aggressive and oscillating, this may cause instability and uncertainty for the missile.

#### 6.4.2.3 PD based guidance results

- Inputs variation

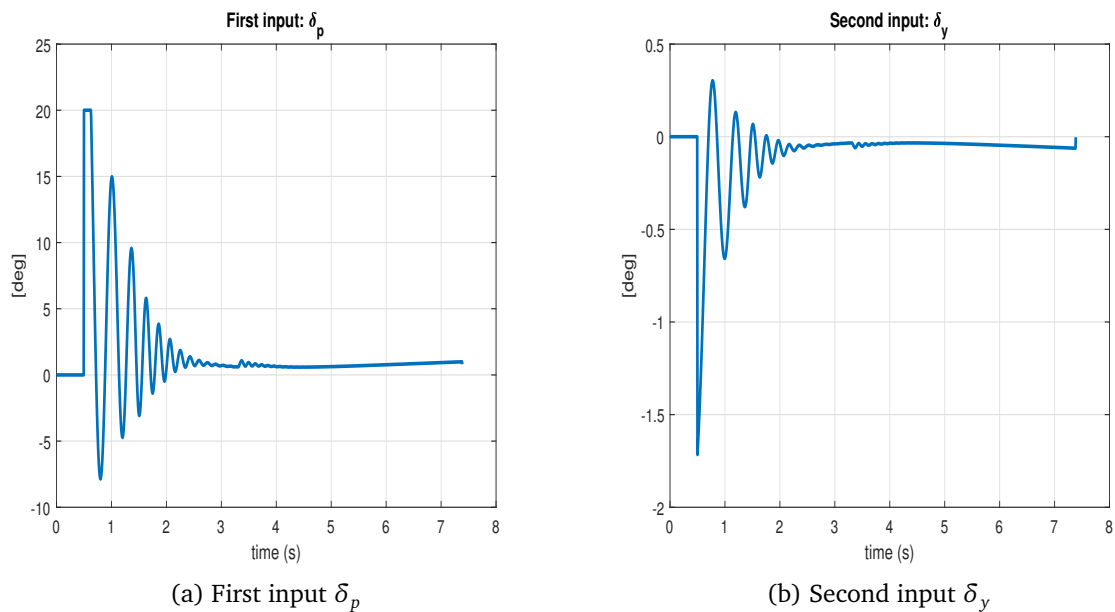

Figure 6.64: First and second inputs variation.

- Lift and Drag forces variation

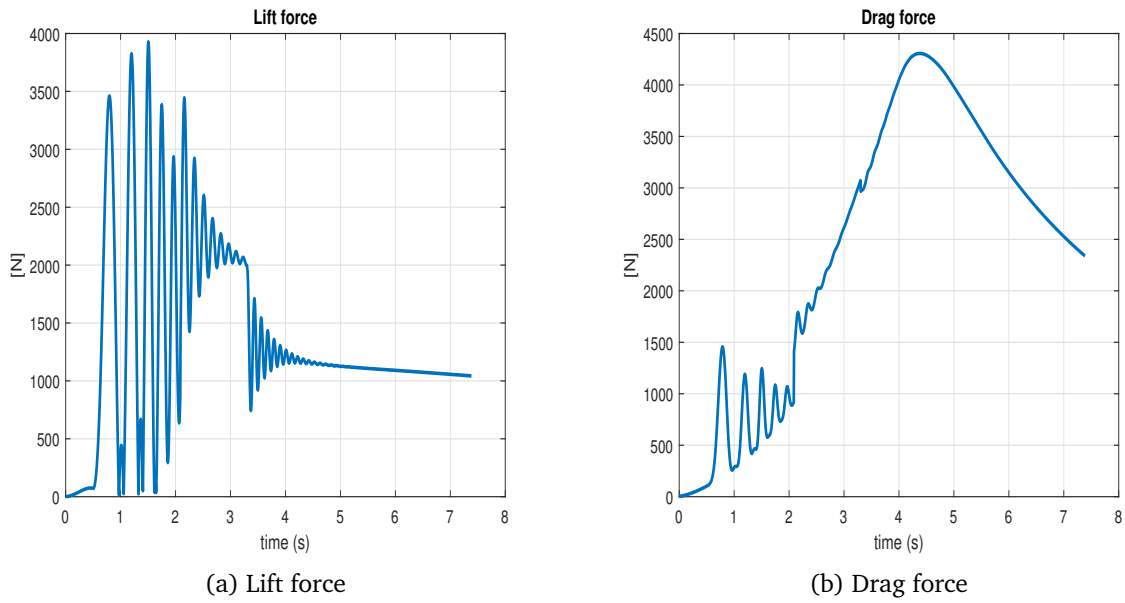

Figure 6.65: Lift and Drag forces variations.

- Angle of attack and Side-slip angle variation

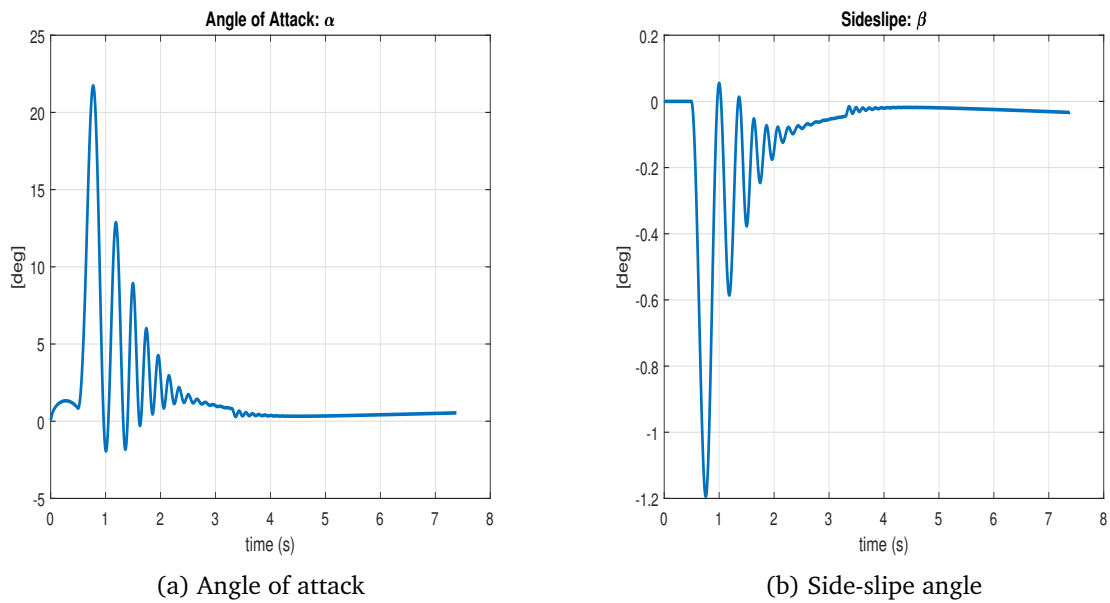

Figure 6.66: Angle of attack and Side-slip angle variation.

- Total angle of attack variation

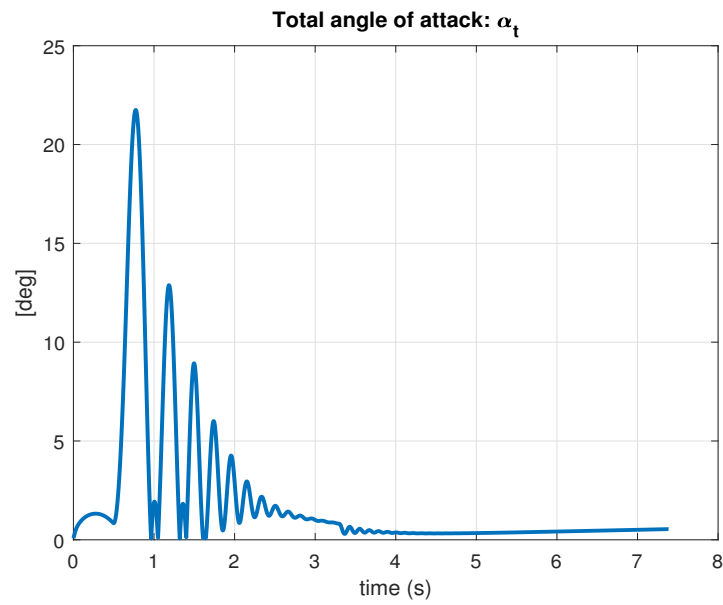

Figure 6.67: Total angle of attack variation.

- Pitch and Yaw moments variation

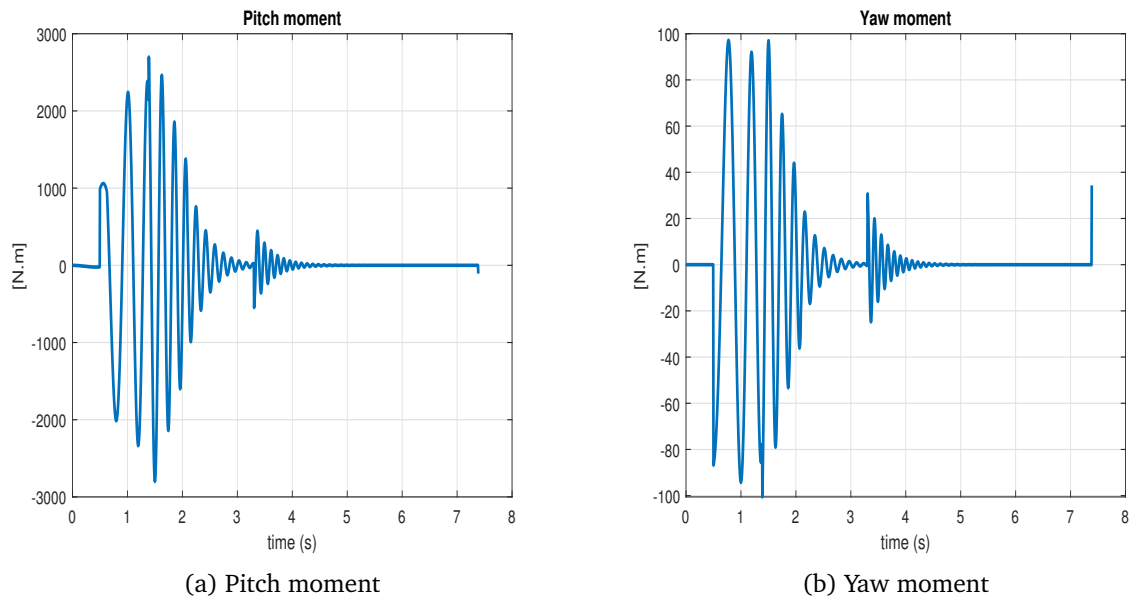

Figure 6.68: Pitch and Yaw moments variation.

- Linear velocities variation

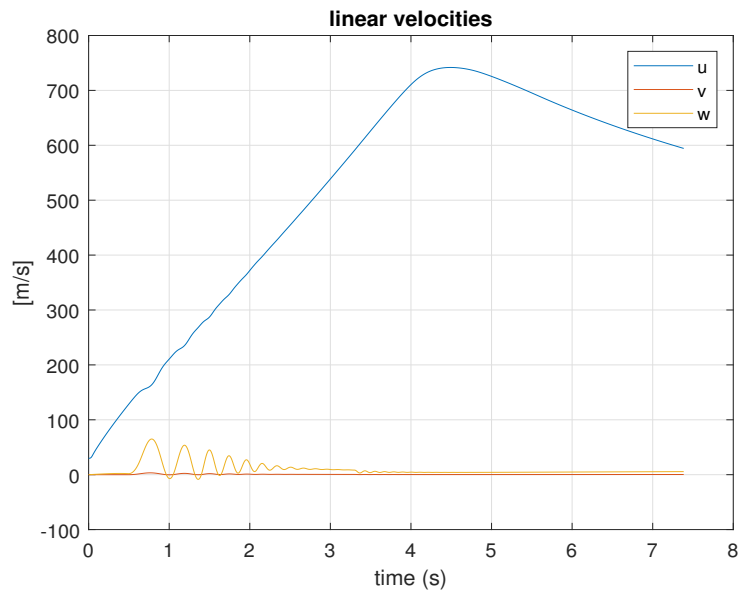

Figure 6.69: Evolution of Linear velocities .

- Angular velocities variation

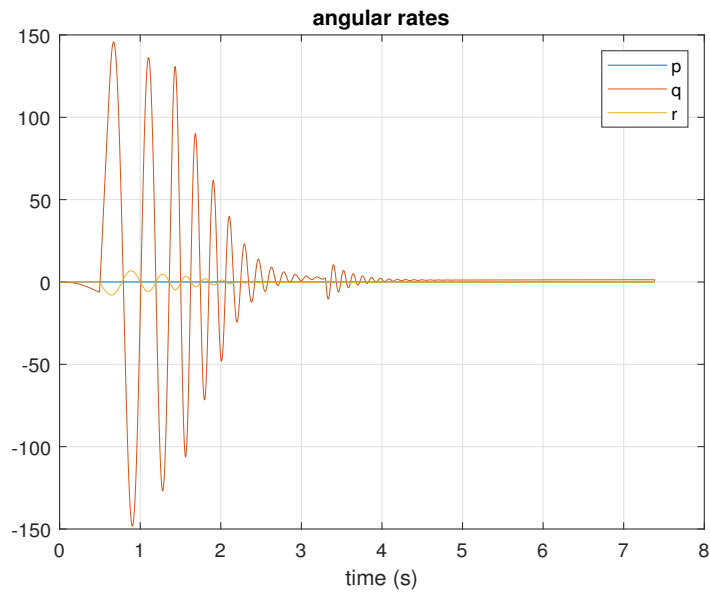

Figure 6.70: Angular velocities variation.



- Euler angles variation

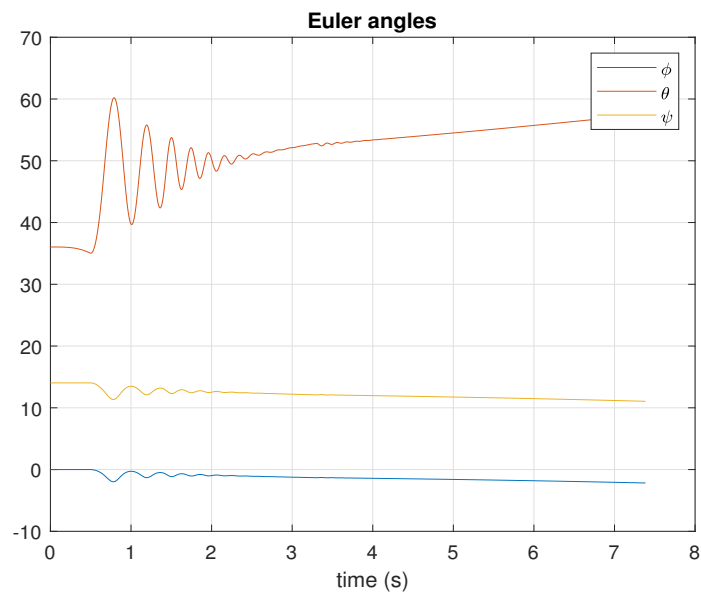

Figure 6.71: Euler angles variation.

- Missile and Target trajectories

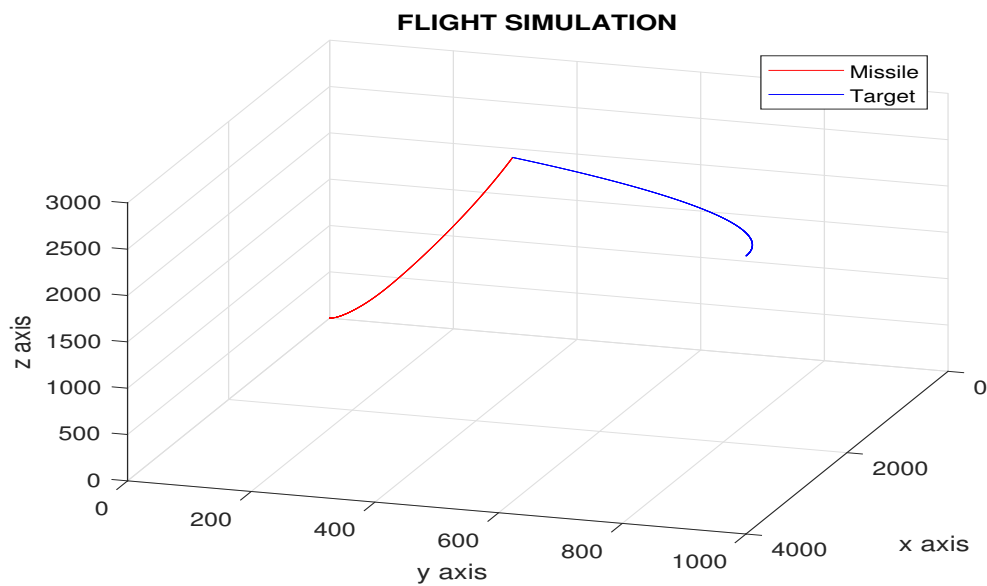

Figure 6.72: Missile and Target engagement in 3 dimensions.

```

Miss_distance =

    0.4799

Time_of_closest_approach =

    7.3853

*****
*----- THE TARGET HAS BEEN DESTROYED -----*
*----- GAME OVER -----*
*****

```

### Discussion:

Figures from 6.64 to 6.72 show the variation of different parameters during the missile engagement when PD guidance applied. The remarkable thing which make this method differs from the others is that the yaw deflection surface deflects in the negative sens after initiating guidance, which make the side-slope angle oscillates in the negative sens as shown in figure 6.66, that in turn affect the variation of the yaw moment (see figure 6.68)

Figure 6.72 shows the missile and the target trajectories and their point of intercept in 3 dimensions. It can be seen that the missile flies approximately in straight line toward the target.

## 6.5 Comparison between simulation results

### 6.5.1 Target in straight flight

	Proportional navigation	CLOS guidance or Beam Rider	PD based guidance
Miss-distance	0.0040 (m)	0.4655 (m)	1.0492 (m)
Time of closest approach	7.4587 (s)	7.5197 (s)	7.4508 (s)

Table 6.1: Comparison between the guidance laws in straight path.

### 6.5.2 Target in weaving flight

	Proportional navigation	CLOS guidance or Beam Rider	PD based guidance
Miss-distance	0.1612 (m)	0.4597 (m)	0.4799 (m)
Time of closest approach	7.4275 (s)	7.5070 (s)	7.3853 (s)

Table 6.2: Comparison between the guidance laws in curved path.

**Discussion:**

According to the comparison tables above, which illustrate the missile performances in both straight and curved path. We observe that

Proportional navigation command shows good tracking, and records the lowest miss-distance in shortest time, thus it is the most well-known used guidance law.

The command to line of sight has also good results in miss-distance, even it tooks more time than the other two methods.

The PD command marked acceptable results due to the utilisation of optimised gains.

The tables also show that the PN scored the lowest miss-distance, while the PD scored the shortest time of closest approach.

Another criteria that is not mentioned in this study which is the energy in control signals (commanded accelerations) showed that the PD based guidance law generates very high control signals. These signals must be limited by limiters and conditions on the commanded accelerations to make this method more realistic.

In general, the dynamics still the same but the performances depend on the applied guidance law.

# General conclusion

In this dissertation, we've presented a comparative study between three guidance laws, namely the *proportional navigation*, the *beam-rider* or *LOS* command guidance and *PD based guidance law*, when applied to the dynamics of a generic surface to air missile.

After an introduction of the missile's modeling, aerodynamic concepts and theoretical foundation of different guidance laws, this work was divided mainly into two parts. The first part addresses the mathematical modeling of a missile. The second part, however, contributed to the design of guidance laws that allow better performances and accuracy. The three synthesized guidance laws *proportional navigation*, the *beam-rider* or *LOS* command guidance and *PD based guidance law*, were compared in terms of their performance to achieve the control objective and their characteristics as well. Overall, we conclude from this study that the *PN* outperforms the other methods in terms of miss-distance, while *PD* guidance is better in terms of time of closest approach.

The work conducted in this thesis can be extended in different directions. For instance, one may reconsider the modeling of disturbances and introduce the concept of noise and filtering even for the target or missile, one also may reconsider a target making random evasive maneuvers. Moreover, for such type of developed models more sophisticated guidance laws could be applied and tested, for example Higher order sliding mode, adaptive controllers, and augmented or extended PN.

# Appendix A

## Appendix

### A.1 MATLAB programs

#### A.1.1 Missile flight simulation CODE

```
1 %% MISSILE FLIGHT SIMULATION=====
2 % this program is a simulation of missile flight written in MATLAB CODE
3
4 clear all
5 close all
6 clc
7
8 %% INITIAL CONDITIONS
9 velocity = [];altitude = [];temperature = [];gravity = [];pressure = [];
10 air_density = [];mass_v = [];inertia = [];center_g = [];pousse = [];
11 attack_angle = [];sideslope = [];mach_number = [];
12 sound_speed = [];pitch = [];yaw = [];roll = [];
13 total_attack = [];
14 lift = [];
15 drag = [];
16 Pm = [];Pt = [];
17 y1 = [];y2 = [];y3 = [];y4 = [];y5 = [];y6 = [];y7 = [];y8 = [];y9 = [];
18 u1 = [];u2 = [];
19
20 mo = 85.0; % missile mass at launch [Kg]
21 mbo = 57.0; % missile mass at burnout [Kg]
22 Io = [0.7 0 0;...
23       0 61 0;...
24       0 0 61]; % moment of inertia about x,y and z axes at launch [Kg.m^2]
25 Ibo = [0.45 0 0;...
26        0 47 0;...
27        0 0 47]; % moment of inertia about x,y and z axes at launch [Kg.m^2]
28 xcmo = 1.55; % distance from nose to center of mass at launch [m]
29 xcmb0 = 1.35; % distance from nose to center of mass at burnout [m]
30 do = 0.127; % aerodynamic reference length(missile's diameter [m]
31 l = 1.6; % fuselage length (length from missile tile to center of mass [m]
32 S = 0.0127; % missile aerodynamic reference area [m^2]
33 x_ref = 1.35; % distance from missile's nose to reference moment station [m]
34 rho_o = 1.223; % air density at sea level [Kg/m^3]
35 T1 = 288.1667; % temperature at sea level [K]
36 a = 0.0065; % lapse rate [K/m]
37 Rg = 287.26; % gas constant [N.m/(Kg.k)]
38 R_e = 6378000; % earth radius at equator [m]
39 g_o = 9.80665; % acceleration due to gravity [m/s^2]
```

```

40 p_ref = 101314; % reference ambient pressure [pa]
41 gama = 1.4 ; % ratio of specific heat
42 Ae = 0.011; % exit area of rocket nozzle [m^2]
43 I_sp = 2224; % specific impulse [N.s/Kg]
44
45 P_M = [0 0 0]; % missile's initial position
46 P_T = [4000 1000 -3000] ; % target's initial position
47 V_T = [-250 0 0]; % target initial velocity [m/s]
48 V_Mn = 30; % magnitude of missile initial velocity
49 R = P_T-P_M; % range vector from missile to target
50 u_r = R/norm(R); % unit range vector
51 u_cl = u_r ; % unit centerline vector
52 V_M = V_Mn*u_cl;
53
54 psi = atan(u_cl(2)/u_cl(1));
55 tita = atan(-u_cl(3)/sqrt((u_cl(1))^2+(u_cl(2))^2));
56 phi = 0;
57 p = 0; q = 0; r = 0; % initial angular velocities
58
59 T_be = [cos(psi)*cos(tita) cos(tita)*sin(psi) -sin(tita);...
60         -sin(psi) cos(psi) 0;...
61         cos(psi)*sin(tita) sin(psi)*sin(tita) cos(tita)];
62 T_eb = T_be';
63
64 V_m = T_be*V_M';
65 u = V_m(1);
66 v = V_m(2);
67 w = V_m(3);
68
69 V_M = V_M';
70
71 alpha = 0; beta = 0; alpha_t = 0; % initial angles
72
73 t_bo = 5.6; % time of burnout [s]
74 t_max = 60; % maximum time of flight [s]
75 Delta_t = 0.005; % integration time step [s]
76 t = 0; % initial time
77
78 xcm = 1.55; % distance from nose to center of mass at launch [m]
79 I = [0.7 0 0;...
80      0 61 0;...
81      0 0 61]; % moment of inertia about x,y and z axes at launch [Kg.m^2]
82 rho = 1.223; % air density at sea level [Kg/m^3]
83 pres = 101314 ;
84 mass = 85.0; % missile mass at launch [Kg]
85 grav = 9.80665; % acceleration due to gravity [m/s^2]
86 tem = 288.1667; % temperature at sea level [K]
87 alt = 0 ;
88
89 alpha_pa = 0 ;
90 alpha_ya = 0 ;
91 w_ach = [0 0 0] ;
92 w_f = [0 0 0] ;
93 A_Tach = 0;
94 yo = [p;q;r;u;v;w;phi;tita;psi];
95
96 kk = 1;
97 [fref,mass] = trust_1;
98
99 ex_d = 0;ey_d = 0;ez_d = 0;

```

```

100 errorx_d = 0;errorz_d = 0;errorz_d = 0;
101
102 K1 = [10 5.5839 8.4240;-10 -8.0385 7.2738];
103 K2 = [-2.6266 9.8147 6.3610;4.1722 -4.1955 -8.6924];
104
105 %% THE LOOP
106 %%
107
108 while t <= t_max
109
110 %% ATMOSPHERE
111 alt0 = 0;
112 tem = T1 - a*(alt-alt0); % temperature
113 grav = g_o*(R_e^2/(R_e+alt)^2); % variation of gravity at diff levels
114 pres = p_ref*exp((-g_o./(tem*Rg))*(alt-alt0));
115 rho = pres/(Rg*tem); % air density
116
117 %% MACH NUMBER
118 v_s = sqrt(gama*Rg*tem); % speed of sound
119 M_n = norm(V_M)/v_s ; % mach number
120 if( M_n>=0 & M_n<0.8)
121 C_Do = 0.8;C_La = 38;C_ma = -160;C_ms = 180;C_m_n = -6000 ;K = 0.0255; %
    aerodynamic coefficients
122 end
123 if( M_n>=0.8 & M_n<1.14)
124 C_Do = 0.8;C_La = 39;C_ma = -170;C_ms = 250;C_m_n = -13000 ;K = 0.0305; %
    aerodynamic coefficients
125 end
126 if( M_n>=1.14 & M_n<1.75)
127 C_Do = 1.2;C_La = 56;C_ma = -185;C_ms = 230;C_m_n = -16000 ;K = 0.0361; %
    aerodynamic coefficients
128 end
129 if( M_n>=1.75 & M_n<2.5)
130 C_Do = 1.15;C_La = 55;C_ma = -235;C_ms = 130;C_m_n = -13500 ;K = 0.0441; %
    aerodynamic coefficients
131 end
132 if( M_n>=2.5 & M_n<3.5)
133 C_Do = 1.05;C_La = 40;C_ma = -190;C_ms = 80;C_m_n = -10000 ;K = 0.0540; %
    aerodynamic coefficients
134 end
135 if( M_n>=3.5)
136 C_Do = 0.94;C_La = 33;C_ma = -150;C_ms = 45;C_m_n = -6000 ;K = 0.0665; %
    aerodynamic coefficients
137 end
138
139 %% DYNAMIC PRESSURE
140 Q = .5*rho*(norm(V_M)).^2;% dynamic pressure
141
142 %% RELATIVE POSITION AND VELOCITY
143 %-----
144 V_tm = V_T - V_M' ;% relative velocity
145 u_tm = V_tm./norm(V_tm);
146 R_prev = norm(R) ;
147 R = P_T-P_M; % range vector from missile to target
148 R_next = norm(R) ;
149 if (R_prev-R_next) < 0
150     M_d = R - dot(R,u_tm)*u_tm;
151     norm(M_d)
152     t_ca = t - dot(R,u_tm)/norm(V_tm)
153     disp('***** ' )

```

```

154     disp(' *----- THE TARGET HAS BEEN DESTROYED -----* ')
155     disp(' *----- GAME OVER -----* ')
156     disp(' ***** ')
157     break
158 end
159
160 u_r = R/norm(R);% unit range vector
161 V_c = -dot(u_r,V_tm) ;% closing speed
162
163
164 %% SEEKER-----
165 % in this part we will use two different guidance laws
166
167 %% PROPORTIONAL NAVIGATION
168 tau1 = 0.01 ;
169 tau2 = 0.01 ;
170 wsm = 25;
171 lamdam = 40;
172 tgon = .59;
173 tau3 = 0.04;
174 sigma_max = .3491;
175 NR = 4 ;
176 Gn = 250;
177 % Gn = 254.1;
178 tnr = 1;
179 gam = R;
180 u_sa = gam/(norm(gam));
181 lamda = acos(dot(u_sa,u_cl));
182 w_g = (cross(gam,V_tm)/norm(gam)^2);
183 w_ach = w_ach*exp(-Delta_t/tau1) + w_g*(1-exp(-Delta_t/tau1));
184 w_f = w_f*exp(-Delta_t/tau2) + w_ach*(1-exp(-Delta_t/tau2));
185 Gs = NR*norm(V_M);
186 Ac = Gs*(cross(w_f,u_cl));
187 % if t < tgon
188 % Ac = [0 0 0];
189 % end
190 Acb = T_be*Ac';
191
192 %% BEAM RIDER AND COMMAND TO LINE OF SIGHT-----
193 % u_gl = P_T./norm(P_T);
194 % P_B = (dot(u_gl,P_M))*u_gl;
195 % e = P_B-P_M;
196 % V_Mp = cross(cross(u_gl,V_M),u_gl) ;
197 % w_gl = V_T*(P_T(3)/(norm(P_T))^2);
198 % w_gl = w_f ;
199 % V_Bp = cross(w_gl,P_B);
200 % e_d = V_Bp - V_Mp ;
201 % u_c = cross(w_gl,u_cl)./norm(cross(w_gl,u_cl));
202 % A_c_c = norm(cross(w_gl,(dot(V_M,u_gl).*u_gl)));
203 % k1 = 4.07675;
204 % k2 = -0.012;
205 % k3 = 0.1151;
206 % Ac = k1*e + k2*e_d + k3*A_c_c*u_c ;
207 % Acb = T_be*Ac';
208
209 %% MIMO PID MISSILE
210 ex = P_T(1)-P_M(1);
211 ey = P_T(2)-P_M(2);
212 ez = P_T(3)-P_M(3);
213

```



```

214 errorx_d = (ex - ex_d(kk))/Delta_t;
215 errory_d = (ey - ey_d(kk))/Delta_t;
216 errorz_d = (ez - ez_d(kk))/Delta_t;
217
218 sigmaa = K1*[tanh(ex);tanh(ey);tanh(ez)]+K2*[tanh(errorx_d);tanh(errory_d);
    tanh(errorz_d)];
219 % sigma_p = sigmaa(1);
220 % sigma_y = sigmaa(2);
221 % Acb = [0 sigmaa(1) sigmaa(2)];
222 % Acb = T_be*Ac';
223
224 %% GUIDANCE AND CONTROL-----
225 alpha_p = -Gn*Acb(3)/Q;
226 alpha_y = Gn*Acb(2)/Q;
227 alpha_pa = alpha_pa*exp(-Delta_t/tau3) + alpha_p*(1-exp(-Delta_t/tau3));
228 alpha_ya = alpha_ya*exp(-Delta_t/tau3) + alpha_y*(1-exp(-Delta_t/tau3));
229
230 sigma_p = alpha_pa - alpha;
231 sigma_y = alpha_ya - beta;
232
233 % sigma_p = sigmaa(1);
234 % sigma_y = sigmaa(2);
235
236 if t < tgon
237 sigma_p = 0 ;
238 sigma_y = 0 ;
239 end
240
241 % if abs(sigma_p)> sigma_max
242 %     abs(sigma_p) = sigma_max;
243 % end
244 % if abs(sigma_y)> sigma_max
245 %     abs(sigma_y) = sigma_max;
246 % end
247
248 if sigma_p >= sigma_max
249     sigma_p = sigma_max;
250 end
251 if sigma_y >= sigma_max
252     sigma_y = sigma_max;
253 end
254 if sigma_p <= -sigma_max
255     sigma_p = -sigma_max;
256 end
257 if sigma_y <= -sigma_max
258     sigma_y = -sigma_max;
259 end
260
261 %% inputs
262 sigma_r = 0;
263
264 %% AERODYNAMICS
265 C_L = C_La*alpha_t;% lift coefficient
266 C_D = C_Do + K*C_L^2;% drag coefficient
267 L = Q*S*C_L;% lift force
268 D = Q*S*C_D;% drag force
269 A = D*cos(alpha_t)-L*sin(alpha_t); % axial force
270 N = D*sin(alpha_t)+L*cos(alpha_t); % normal force
271 F_a = [-A N*(-v/sqrt(v^2 + w^2)) N*(-w/sqrt(v^2 + w^2))];% aerodynamic force
272 Cnz = F_a(3)/(Q*S);

```

```

273 Cny = F_a(2)/(Q*S);
274 C_mref = C_ma*alpha + C_ms*sigma_p;
275 C_nref = C_ma*beta + C_ms*sigma_y;
276 %C_l = C_ls*sigma_r + (do/(2*norm(V_mb)))*C_lp*y(1);
277 C_m = C_mref - Cnz*((xcm-x_ref)/do) + (do/(2*norm(V_M)))*(C_m_n)*q;
278 C_n = C_nref + Cny*((xcm-x_ref)/do) + (do/(2*norm(V_M)))*(C_m_n)*r;
279 L_a = Q*S*do*0;%*C_l;% moment about roll axis
280 M_a = Q*S*do*C_m;% moment about pitch axis
281 N_a = Q*S*do*C_n;% moment about yaw axis
282
283 %% PROPULSION
284 if t >= 5.6
285     fref(kk) = 0;
286 end
287
288 fp = fref(kk) + (p_ref - pres)*Ae ;
289 F_p = [fp 0 0];% propulsion force
290
291 %% GRAVITY
292 F_g = [-mass(kk)*grav*sin(tita) mass(kk)*grav*cos(tita)*sin(phi) mass(kk)*
        grav*cos(tita)*cos(phi)];% gravity force
293 pousse = [pousse;v_s];
294
295 %% RUNGR-KUTTA method
296 %-----
297 H = Delta_t;
298 HH = H/2;
299 H6 = H/6;
300 % first step
301 V = yo ;
302 dydx = derivs(mass(kk),I,L_a,M_a,N_a,F_a,F_g,F_p,V) ;
303 yt = yo + HH*dydx' ;
304 % second step
305 V = yt ;
306 dyt = derivs(mass(kk),I,L_a,M_a,N_a,F_a,F_g,F_p,V) ;
307 yt = yo + HH*dym' ;
308 % third step
309 V = yt ;
310 dym = derivs(mass(kk),I,L_a,M_a,N_a,F_a,F_g,F_p,V) ;
311 yt = yo + H*dym' ;
312 dym = dyt + dym ;
313 % fourth step
314 V = yt ;
315 dyt = derivs(mass(kk),I,L_a,M_a,N_a,F_a,F_g,F_p,V) ;
316 yout = yo + H6*(dydx' + dyt' + 2*dym');
317 %-----
318 d = yout;
319 p = d(1);q = d(2);r = d(3);u = d(4);v = d(5);w = d(6);phi = d(7);
320 tita = d(8);psi = d(9);
321
322 yo = [p;q;r;u;v;w;phi;tita;psi];
323 y1 = [y1;p];y2 = [y2;q];y3 = [y3;r];y4 = [y4;u];y5 = [y5;v];
324 y6 = [y6;w];y7 = [y7;phi];y8 = [y8;tita];y9 = [y9;psi];
325
326 %% MISSILE POSITION
327 T_be = [cos(psi)*cos(tita) cos(tita)*sin(psi) -sin(tita);...
        -sin(psi) cos(psi) 0;...
        cos(psi)*sin(tita) sin(psi)*sin(tita) cos(tita)];
328
329 T_eb = T_be';
330 V_m = [u;v;w];

```

```

332 V_M = T_eb*V_m ;
333 % P_M = position(V_M) + P_M;
334 P_M = P_M + V_M'.*(Delta_t) ;
335
336 %% TARGET POSITION
337 % V_T = [-250 0 0]; % target initial velocity [m/s]
338 ng = L/mass(kk)*grav ; % load factor
339 Amax = grav.*sqrt(4);
340 % Amax = .6;
341 tmi = 1;
342 Pd = 120 ;
343 tau4 = 0.01;
344 % A_Tc = Amax*sign(cos(2*pi*tmi/Pd));
345 A_Tc = Amax*cos(2*pi*tmi/Pd);
346 A_Tach = A_Tach*(exp(-Delta_t/tau4)) + A_Tc*(1-exp(-Delta_t/tau4));
347 w_t = [0 0 A_Tc/norm(V_T)] ;
348 A_T = cross(w_t,V_T);
349 V_T = V_T + A_T*Delta_t;
350 P_T = P_T + V_T.*(Delta_t) + A_T.*Delta_t^2/2;% target position
351 % P_T = P_T + V_T.*(Delta_t) + A_T/2;% target position
352
353 %% MISSILE ALTITUDE
354 alt = -P_M(3); % missile altitude
355 altitude = [altitude;alt];
356
357 %% UPDATING
358 t = t + Delta_t ; % time updating
359 kk = kk +1 ;
360 ex_d = [ex_d;ex];
361 ey_d = [ey_d;ey];
362 ez_d = [ez_d;ez];
363 % p1 = 306.31;p2 = -4310.4;p3 = 21066;p4 = -42224;p5 = 29337;p6 = 12043;
364 % mass = 85 - (1/I_sp)*(p1/6)*t.^6 + (p2/5)*t.^5 + (p3/4)*t.^4 + (p4/3)*t.^3
    + (p5/2)*t.^2 + (p6)*t);
365 if t>=t_bo
366     mass(kk) = 56.618;
367 end
368 mass_v = [mass_v;mass(kk)];
369 xcm = xcmo - (xcmo-xcmbo)*((mo-mass(kk))/(mo-mbo));
370 center_g = [center_g;xcm];
371 I = Io - (Io-Ibo)*((mo-mass(kk))/(mo-mbo));
372 inertia = [inertia;(diag(I))'];
373 u_cl = [cos(tita)*cos(psi) cos(tita)*sin(psi) sin(-tita)];
374 u_vm = V_M/norm(V_M);
375 alpha = atan(w/u); % angle of attack
376 beta = atan(-v/u); % angle of sideslip
377 alpha_t = acos(dot(u_vm,u_cl));% alpha total
378 % alpha_t = acos(u/norm(V_M));
379
380 Pm = [Pm;P_M];
381 Pt = [Pt;P_T];
382 RTD = 180/pi;
383 u1 = [u1;sigma_p*RTD];
384 u2 = [u2;sigma_y*RTD];
385 temperature = [temperature;tem];
386 gravity = [gravity;grav];
387 air_density = [air_density;rho];
388 pressure = [pressure;pres];
389 attack_angle = [attack_angle;alpha*RTD];
390 total_attack = [total_attack;alpha_t*RTD];

```

```

391 sideslipe = [sideslipe;beta*RTD];
392 mach_number = [mach_number;M_n];
393 sound_speed = [sound_speed;v_s];
394 pitch = [pitch;M_a];
395 yaw = [yaw;N_a];
396 lift = [lift;L];
397 drag = [drag;D];
398
399
400 end
401 tt = [0:length(u1)-1]*0.005;
402 tt = tt';
403 figure
404 xm = Pm(:,1); ym = Pm(:,2); zm = Pm(:,3);
405 xt = Pt(:,1); yt = Pt(:,2); zt = Pt(:,3);
406 plot3(xm,ym,-zm,'r','linewidth',1.5)
407 hold on
408 plot3(xt,yt,-zt,'b','linewidth',1.5)
409 hold all
410 grid on
411 xlabel('x axis')
412 ylabel('y axis')
413 zlabel('z axis')
414 title('FLIGHT SIMULATION')
415 legend({'Missile','Target'},'Location','northeast','NumColumns',1)
416 %% %% Plot States
417 %% %%
418
419 y = [y1 y2 y3 y4 y5 y6 y7 y8 y9];
420
421 figure
422 y1 = y(:,1).*180/pi;
423 plot(tt,y1)
424 grid on
425 hold on
426 y2 = y(:,2).*180/pi;
427 plot(tt,y2)
428 grid on
429 hold on
430 y3 = y(:,3).*180/pi;
431 plot(tt,y3)
432 grid on
433 hold on
434 legend({'p','q','r'},'Location','northeast','NumColumns',1)
435 xlabel('time (s)')
436 title('angular rates')
437
438 figure
439 y4 = y(:,4);
440 plot(tt,y4)
441 grid on
442 hold on
443 y5 = y(:,5);
444 plot(tt,y5)
445 grid on
446 hold on
447 y6 = y(:,6);
448 plot(tt,y6)
449 grid on
450 hold on

```

```
451 legend({'u', 'v', 'w'}, 'Location', 'northeast', 'NumColumns', 1)
452 xlabel('time (s)')
453 ylabel('[m/s]')
454 title('linear velocities')
455
456 figure
457 y7 = y(:,7).*180/pi;
458 plot(tt,y7)
459 grid on
460 hold on
461 y8 = y(:,8).*180/pi;
462 plot(tt,y8)
463 grid on
464 hold on
465 y9 = y(:,9).*180/pi;
466 plot(tt,y9)
467 grid on
468 hold on
469 legend({'\phi', '\theta', '\psi'}, 'Location', 'northeast', 'NumColumns', 1)
470 xlabel('time (s)')
471 title('Euler angles')
472 %%
473 figure
474 %subplot(221)
475 plot(tt,temperature,'linewidth',2)
476 hold on
477 grid on
478 xlabel('time (s)')
479 ylabel('[K]')
480 title('Temperature variation')
481 figure
482 %subplot(222)
483 plot(tt,pressure,'linewidth',2)
484 hold on
485 grid on
486 xlabel('time (s)')
487 ylabel('[pa]')
488 title('Pressure variation')
489 figure
490 %subplot(223)
491 plot(tt,air_density,'linewidth',2)
492 hold on
493 grid on
494 xlabel('time (s)')
495 ylabel('[kg/m^3]')
496 title('Air density variation')
497 figure
498 %subplot(224)
499 plot(tt,gravity,'linewidth',2)
500 hold on
501 grid on
502 xlabel('time (s)')
503 ylabel('[m/s^2]')
504 title('Gravity variation')
505
506 figure
507 plot(tt,mass_v,'linewidth',2)
508 hold on
509 grid on
510 xlabel('time (s)')
```

```
511 ylabel('[kg]')
512 title('Mass variation')
513
514 figure
515 %subplot(121)
516 plot(tt,pitch,'linewidth',2)
517 hold on
518 grid on
519 xlabel('time (s)')
520 ylabel('[N.m]')
521 title('Pitch moment')
522 figure
523 %subplot(122)
524 plot(tt,yaw,'linewidth',2)
525 hold on
526 grid on
527 xlabel('time (s)')
528 ylabel('[N.m]')
529 title('Yaw moment')
530
531 figure
532 %subplot(121)
533 plot(tt,mach_number,'linewidth',2)
534 hold on
535 grid on
536 xlabel('time (s)')
537 ylabel('[]')
538 title('Mach number')
539 figure
540 %subplot(122)
541 plot(tt,sound_speed,'linewidth',2)
542 hold on
543 grid on
544 xlabel('time (s)')
545 ylabel('[m/s]')
546 title('Sound speed')
547
548 figure
549 %subplot(121)
550 plot(tt,u1,'linewidth',2)
551 hold on
552 grid on
553 xlabel('time (s)')
554 ylabel('[deg]')
555 title('First input: \delta_{p}')
556 figure
557 %subplot(122)
558 plot(tt,u2,'linewidth',2)
559 hold on
560 grid on
561 xlabel('time (s)')
562 ylabel('[deg]')
563 title('Second input: \delta_{y}')
564
565 figure
566 %subplot(121)
567 plot(tt,attack_angle,'linewidth',2)
568 hold on
569 grid on
570 xlabel('time (s)')
```

```
571 ylabel(' [deg]')
572 title('Angle of Attack: \alpha')
573 figure
574 %subplot(122)
575 plot(tt,sideslpe,'linewidth',2)
576 hold on
577 grid on
578 xlabel('time (s)')
579 ylabel(' [deg]')
580 title('Sideslpe: \beta')
581
582 figure
583 %subplot(221)
584 plot(tt,inertia(:,1),'linewidth',2)
585 hold on
586 grid on
587 xlabel('time (s)')
588 ylabel(' [kg.m^2]')
589 title('I_x')
590 figure
591 %subplot(222)
592 plot(tt,inertia(:,2),'linewidth',2)
593 hold on
594 grid on
595 xlabel('time (s)')
596 ylabel(' [kg.m^2]')
597 title('I_y')
598 figure
599 %subplot(223)
600 plot(tt,inertia(:,3),'linewidth',2)
601 hold on
602 grid on
603 xlabel('time (s)')
604 ylabel(' [kg/m^2]')
605 title('I_z')
606 figure
607 %subplot(224)
608 plot(tt,center_g,'linewidth',2)
609 hold on
610 grid on
611 xlabel('time (s)')
612 ylabel(' [m]')
613 title('Mass center')
614
615 figure
616 plot(tt,total_attack,'linewidth',2)
617 hold on
618 grid on
619 xlabel('time (s)')
620 ylabel(' [deg]')
621 title('Total angle of attack: \alpha_t')
622
623 figure
624 %subplot(121)
625 plot(tt,lift,'linewidth',2)
626 hold on
627 grid on
628 xlabel('time (s)')
629 ylabel(' [N]')
630 title('Lift force')
```

```
631 figure
632 %subplot(122)
633 plot(tt,drag,'linewidth',2)
634 hold on
635 grid on
636 xlabel('time (s)')
637 ylabel('[N]')
638 title('Drag force')
```



## A.1.2 ODE's function CODE

```
1 function h = derivs(mass,I,L_a,M_a,N_a,F_a,F_g,F_p,V)
2
3 y = V ;
4
5 % angular velocities-----
6 yout(1) = (L_a - y(2)*y(3)*(I(3,3) - I(2,2)))/I(1,1);
7 yout(2) = (M_a - y(1)*y(3)*(I(1,1) - I(3,3)))/I(2,2);
8 yout(3) = (N_a - y(1)*y(2)*(I(2,2) - I(1,1)))/I(3,3);
9
10 % linear velocities-----
11 yout(4) = -(y(2)*y(6)-y(3)*y(5))+(F_a(1)+F_g(1)+F_p(1))/mass;
12 yout(5) = -(y(3)*y(4)-y(1)*y(6))+(F_a(2)+F_g(2))/mass;
13 yout(6) = -(y(1)*y(5)-y(2)*y(4))+(F_a(3)+F_g(3))/mass;
14
15 % Euler angles (accelerations)-----
16 yout(7) = y(1)+(y(2)*sin(y(7))+y(3)*cos(y(7)))*tan(y(8));
17 yout(8) = y(2)*cos(y(7))-y(3)*sin(y(7));
18 yout(9) = (y(2)*sin(y(7))+y(3)*cos(y(7)))/cos(y(8));
19
20 h = yout ;
21
22 end
```

### A.1.3 THRUST interpolation CODE

```

1 function [a,b] = trust_1()
2
3
4 x=[0 0.01 0.04 0.05 0.08 0.1 0.2 0.3 0.6 1.0 1.5 2.5 3.5 3.8 4.0 4.1...
5 4.3 4.5 4.7 4.9 5.2 5.6];
6 y=[0 450 17800 23100 21300 20000 18200 17000 15000 13800 13300 ...
7 13800 14700 14300 12900 11000 7000 4500 2900 1500 650 0];
8
9 xq = (0:0.005:5.6);
10 vq = interpn(x,y,xq,'pchip');
11
12 % figure
13 % plot(x,y,'o',xq,vq,'--','linewidth',1.7);
14 % grid on
15 % xlabel('Time (s)')
16 % ylabel('Thrust')
17 % title('Thrust variation')
18 % legend('Samples','Cubic Interpolation');
19 %
20
21
22 t=0:0.005:5.6;
23 n=length(t);
24 pp = spline(x,y);
25 ye = ppval(pp,x);
26
27 time=0.005;
28 m0=85;
29
30 for i=1:n
31
32 % m = m0-(integral(@(x)ppval(pp,x),0,time))/2224
33 m(:,i) = m0-(integral(@(x)ppval(pp,x),0,time))/2224;
34 time = time+0.005;
35
36 end
37
38 % figure(2)
39 % plot(t,m,'r-','linewidth',1.7)
40 % xlabel('Time (s)')
41 % ylabel('mass (kg)')
42 % title('Mass variation')
43 % grid on
44
45 a = vq ;
46 b = m ;

```

### A.1.4 PSO Algorithm CODE

```
1 clear all
2 clc
3
4 wmax=0.9;
5 wmin=0.8;
6 c1=0.49;
7 c2=0.49;
8 n=20;
9 itermax=30;
10 xmin=[-2 -2 -.2];
11 xmax=[5 5 .5];
12 m = 3;
13 v = zeros(m,n);
14 rand('state',0);
15
16 for i=1:n
17 for j=1:m
18 x(j,i)=xmin(j)+rand*(xmax(j)-xmin(j));
19 end
20 e(i) = PSO_MISSILE(x(1,i),x(2,i),x(3,i));
21 fun_marge(i)=e(i);
22 end
23
24 xbest = x;
25 fbest = fun_marge;
26 fgbest = min(fun_marge);
27 gbest = x(:,find(fun_marge==fgbest));
28
29
30 for iter=1:itermax
31 w = wmax-(wmax-wmin)*iter/itermax;
32 for i=1:n
33 v(:,i) = w*v(:,i)+c1*rand*(xbest(:,i)-x(:,i))+c2*rand*(gbest-x(:,i));
34 x(:,i) = x(:,i)+v(:,i);
35 for jj = 1:m
36 if x(jj,i)>xmax(jj)
37 x(jj,i)=xmax(jj);
38 end
39 if x(jj,i)<xmin(jj)
40 x(jj,i)=xmin(jj);
41 end
42 end
43
44
45 e(i) = PSO_MISSILE(x(1,i),x(2,i),x(3,i));
46 fun_marge(i)=e(i);
47
48 if fun_marge(i) < fbest(i)
49 xbest(:,i)=x(:,i);
50 fbest(i)=fun_marge(i);
51 end
52 if fun_marge(i) < fgbest
53 gbest=x(:,i);
54 fgbest=fun_marge(i);
55 end
56 end
57 result(iter)=fgbest;
58 end
```

```
59 fprintf(' the optimal value is %3.4f\n', gbest)
60 fprintf(' the minimum value of func is %3.4f\n', fgbest)
61
62 e = PSO_MISSILE(gbest(1), gbest(2), gbest(3));
63 plot([1:itermax], result, '--r', 'linewidth', 1.5)
64 xlabel('Iteration')
65 ylabel('Function')
66 grid on
```

# Appendix B

## Appendix

### B.1 Numerical solution of a differential equation

Differential equations of first order can be solved using variety of mathematical tools. But for solving the equations using different initial conditions and real time inputs, we need a computer generated approximate solution. This is where numerical integration techniques come handy.

Any normal system of differential equations can be written as a first-order normal system, which in vector notation has the form

$$\frac{dY}{dt} = G(t, Y) \quad (\text{B.1})$$

Where

$G(t, Y)$  = vector o function of  $t$  and  $Y$

$t$  = independent variable (time)

$Y$  = vector of dependent variables.

The general solution of this differential equation is given by

$$Y = f(t) \quad (\text{B.2})$$

#### B.1.1 Runge-Kutta Method

The Runge-Kutta method and its variations are very popular simulations. The method provides good accuracy, is simple to program, requires minimum storage, and is stable under most circumstances with integration intervals of reasonable size . The basic derivation of the method involves a summation of terms, the number of which is arbitrary. The most common form of the method is based on the summation of four terms; consequently, it is referred to as the fourth-order Runge-Kutta method. Also in the derivation of the method are certain arbitrary constants. In the fourth-order Runge-Kutta method, the most frequently selected arbitrary constants lead to a set of difference equations of the form.

$$Y_{n+1} = Y_n + \frac{T}{6}(H_1 + 2H_2 + 2H_3 + H_4) \quad (\text{B.3})$$

Where

$H_1 = G(t_n, Y_n)$

$H_2 = G(t_n + 1/2T, Y_n + TH_1)$

$H_3 = G(t_n + 1/2T, Y_n + TH_2)$

$H_4 = G(t_n + T, Y_n + TH_3)$

$T$  = integration step size

$Y_n$  = vector of dependent variables at beginning of step  $n$

$Y_{n+1}$  =vector of dependent variables at beginning of step  $n + 1$

## B.2 Coordinate system

A number of different coordinate systems may be used in a given missile flight simulation. Coordinate systems are characterized by the positions of their origins, their angular orientations, and their motions relative to inertial space or relative to other specified systems. A given vector can be described by its coordinates in any of the coordinate systems. If the coordinates of a vector are given in one reference frame, the coordinates of that vector in any other reference frame can be determined if the position and orientation of one reference frame relative to the other is known.

### B.2.1 Earth Coordinate System ( $x_e, y_e, z_e$ )

In a flat-earth simulation the earth is usually assumed to be fixed in space, i.e., neither translating nor rotating. In this case, absolute accelerations can be measured with respect to any coordinate system fixed to the earth. Such a system is called an earth coordinate system and is commonly used as a basis for measuring accelerations, velocities, and positions of a missile, target, and decoys.

### B.2.2 Body Coordinate System ( $x_b, y_b, z_b$ )

The body coordinate system is fixed to the missile and aligned with the principal axes of the missile. Thus the system is particularly useful for calculations of angular rates because the equations of motion contain no terms involving the products of the moments of inertia and the moments of inertia about the reference frame axes are independent of missile attitude.

### B.2.3 Wind Coordinate System ( $x_w, y_w, z_w$ )

The movement of undisturbed air relative to the missile (relative wind) is tangent to the missile flight path. The wind coordinate system is viewed as being aligned with the relative wind to simplify the calculation of aerodynamic forces and moments. By definition, the aerodynamic drag and lift vectors are aligned with wind system axes.

# Bibliography

- [1] George M . Siouris . "*Missile guidance and control systems*" . Springer-Verlag New York , Inc , 2004.
- [2] Jack N.Nielsen . "MISSILE AERODYNAMICS " . MCGRAW-HILL BOOK COMPANY, INC. New York Toronto London , 1960.
- [3] N.A. SHNEYDOR ."*Missile Guidance and Pursuit: Kinematics, Dynamics and Control*", HORWOOD PUBLISHING LIMITED , International Publishers , Coll House, Westergate, Chichester, West Sussex, PO20 6QL England , 1998.
- [4] SR. Mohan . "*FUNDAMENTALS OF GUIDED MISSILES*", Defence Research And Development Organisation, New Delhi, 2016.
- [5] Rafael Yanushevsky . "*Modern missile guidance*", Taylor , Francis Group LLC, 2019.
- [6] BUREAU OF NAVAL PERSONNEL . "*PRINCIPLES OF GUIDED MESSILES AND NUCLEAR WEAPONS*", Officier Candidate School, Newport, R. I., NROTC unit, University
- [7] Qi Zaikang , Lin Defu . "*Design of Guidance and Control Systems for Tactical Missiles*", Taylor , Francis Group, LLC, Beijing Institute of Technology , 2020.
- [8] Dr. Eugene Leimanis . "*The General Problem of the Motion of Coupled Rigid Bodies about a Fixed Point*", Springer-Verlag, Berlin - Heidelberg Library of Congress Catalog Card Number 65.22096 ,1965.
- [9] Michael J. Hensch . "*Tactical Missile Aerodynamics: General Topics*", The American Institute of Aeronautics and Astronautics, Inc., 370 L'Enfant promenade, SW, Washington, DC, 20024-2518 , 1991.
- [10] Warren J. Boord , John B. Hoffmanv . "*Air and Missile Defense Systems Engineering*", Taylor , Francis Group, LLC, 2016.
- [11] P Garnell , D.J. EAST . "*GUIDED WEAPON CONTROL SYSTEMS*", Pergamon Press Inc. Maxwell House, Fairview Park, Elmsford, New York 10523, U.S.A , 1977.
- [12] John H. Blakelock . "*Automatic Control of Aircraft and Missiles*", "A Wiley-Interscience publication." , 1991.
- [13] S. N. Balakrishnan , A. Tsourdos , B. A. White . "*Advances in Missile Guidance, Control, and Estimation*", Taylor , Francis Group, 2013.
- [14] Bekacem Bekhiti . "*Dynamic Modeling and control of Large Space Structures*", Institute of aeronautics and space studies Blida, 2019.
- [15] Naval Training Command . "*Gunner's Mate Missiles 1 and C*", UNITED STATES GOVERNMENT PRINTING OFFICE WASHINGTON. D.C., 1973.

- [16] NAVAL TRAINING SUPPORT COMMAND . "*Gunner's Mate Missiles 3 and 2*", UNITED STATES GOVERNMENT PRINTING OFFICE WASHINGTON. D.C, 1972.
- [17] R. Balakrishnan . "*GUIDED WEAPONS SYSTEM DESIGN*", Director, DESIDOC, Metcalf House, Delhi-110 054 , 1998.
- [18] Ashish Tewari . "*Atmospheric and Space Flight Dynamics Modeling and Simulation with MATLAB and Simulink*", Department of Aerospace Engineering Indian Institute of Technology, Kanpur India , 2007.
- [19] Bekhiti Belkacem . "*Automatic Control of Aircraft and Missiles- Part I: Dynamic Modeling*", Institute of aeronautics and space studies, 2019.
- [20] G.L. Watts , J.W. McCarter . "*Missile Aerodynamics for Ascent and Re-entry*" , Marshall Space Flight NASA Center for AeroSpace Information 7115 Standard Drive Hanover, November 2012.
- [21] Sethunathan Paramasivam . "*AERODYNAMIC CHARACTERISTICS OF A MISSILE COMPONENTS*", International Journal of Research in Engineering and Technology eISSN, April 2017.
- [22] Walter R. Dyer . "*Modern Missile Analysis Guidance, control, Seekers, and Technology*", 349 Berkshire Drive Riva, Maryland , [www.ATLcourses.com](http://www.ATLcourses.com) ,2009.
- [23] L. F. SHAMPINE, I. GLADWELL, S. THOMPSON . "*Solving ODEs with MATLAB*", Cambridge University Press, 2003.
- [24] Won Young Yang, Wenwu Cao, Tae-Sang Chung, John Morris. "*APPLIED NUMERICAL METHODS USING MATLAB*", JOHN WILEY AND SONS, INC, 2005.
- [25] Jun Sun, Choi-Hong Lai, Xiao-Jun Wu. "*Particle Swarm Optimisation Classical and Quantum Perspectives*". Taylor and Francis Group, LLC, 2012
- [26] Slami Saadi. "*Introduction a l'optimisation meta-heuristique*", Dar Kifaya, Bab-Ezzouar, Algeria, 2019.
- [27] Alim Mohammed, Zouheir Belkhatir. "*Intelligent control of the lateral motion of Boeing 747*", Master thesis, Blida institute of aeronautics and space studies, 2019.
- [28] Jeff Scott. "*Aerospaceweb.org*", 1 august 2004, <http://www.aerospaceweb.org>